

**SERIES
681XXB
SYNTHESIZED SWEEP GENERATOR
OPERATION MANUAL**

Wiltron

WARRANTY

The WILTRON product(s) listed on the title page is (are) warranted against defects in materials and workmanship for one year from the date of shipment, except for YIG-tuned oscillators and all WILTRON manufactured microwave components, which are warranted for two years.

WILTRON's obligation covers repairing or replacing products which prove to be defective during the warranty period. Buyers shall prepay transportation charges for equipment returned to WILTRON for warranty repairs. Obligation is limited to the original purchaser. WILTRON is not liable for consequential damages.

LIMITATION OF WARRANTY

The foregoing warranty does not apply to WILTRON connectors that have failed due to normal wear. Also, the warranty does not apply to defects resulting from improper or inadequate maintenance by the Buyer, unauthorized modification or misuse, or operation outside of the environmental specifications of the product. No other warranty is expressed or implied, and the remedies provided herein are the Buyer's sole and exclusive remedies.

NOTICE

WILTRON Company has prepared this manual for use by WILTRON Company personnel and customers as a guide for the proper installation, operation, and maintenance of WILTRON Company equipment and computer programs. The drawings, specifications, and information contained herein are the property of WILTRON Company, and any unauthorized use or disclosure of these drawings, specifications, and information is prohibited; they shall not be reproduced, copied, or used in whole or in part as the basis for manufacture or sale of the equipment or software programs without the prior written consent of WILTRON Company.

Wiltron

Declaration of Conformity

Application of Council Directive: EMC- 89/336/EEC

Manufacturer: Wiltron Company
490 Jarvis Drive
Morgan Hill, CA 95037
USA

Products: Synthesized CW / Sweep / Signal Generators

Models: 680XXB, 681XXB, 682XXB, 683XXB

Standards: EN 55011: 1991, Group 1, Class A

EN 50082-1: 1992
IEC 801-2, 1991, Level 3
IEC 801-3, 1984, Level 2
IEC 801-4, 1988, Level 2



Signature

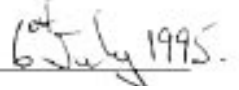

Date

John Pink
Managing Director
Wiltron Measurements LTD.
Wiltron House
Rutherford Close
Stevenage
Herts, SG1 2EF
UNITED KINGDOM

TABLE OF CONTENTS

Chapter 1 — General Information

Chapter 1 provides general information about the WILTRON Series 681XXB Synthesized Sweep Generator. It includes a general description of the sweep generator and information on its identification number, related manuals, options, and performance specifications. A listing of recommended test equipment is also provided. Chapter contents are detailed immediately following the tab.

Chapter 2 — Installation

Chapter 2 provides installation instructions for the Series 681XXB Synthesized Sweep Generator. It includes information on initial inspection, preparation for use, storage, and reshipment, and GPIB setup and interconnections. Chapter contents are detailed immediately following the tab.

Chapter 3 — Local (Front Panel) Operation

Chapter 3 provides information and instructions for operating the Series 681XXB Synthesized Sweep Generator using the front panel controls. It includes illustrations of the front panel, data display area, and data entry area; an annotated diagram of the menu display format; and instructions for performing sweep generator operations. Chapter contents are detailed immediately following the tab.

Chapter 4 — Local Operation—Menu Maps

Chapter 4 provides menu maps that support the local (front panel) operating instructions found in Chapter 3. It includes menu maps for all of the frequency, power level, and modulation modes of operation plus system configuration. Chapter contents are detailed immediately following the tab.

Chapter 5 — Operation Verification

Chapter 5 provides three operation verification tests that can be used to verify Series 681XXB Synthesized Sweep Generator operation. Setup instructions and step-by-step procedures are included for each test. Test results can be compared with the specified limits shown on the test record forms that are provided for each 681XXB model configuration. Chapter contents are detailed immediately following the tab.

Chapter 6 — Operator Maintenance

Chapter 6 provides the information necessary for operator maintenance of the sweep generator. Operator maintenance is limited to basic troubleshooting and repairs that can be made without removing the instrument covers. Chapter contents are detailed immediately following the tab.

Chapter 7 — Use With Other Instruments

Chapter 7 provides information and instructions for using the Series 681XXB Synthesized Sweep Generator with other WILTRON instruments. Chapter contents are detailed immediately following the tab.

Table of Contents (Continued)

Appendix A — Rear Panel Connectors

Appendix A provides descriptions of the rear panel connectors on a typical Series 681XXB Synthesized Sweep Generator. It includes pinout diagrams and descriptions for the AUX I/O and IEEE-488 GPIB connectors.

Appendix B — Performance Specifications

Appendix B lists the performance specifications for the Series 681XXB Synthesized Sweep Generator.

Supplements

This tab provides a repository for application notes and other material used to supplement manual chapters.

Index

Provides a subject index.

Chapter 1

General Information

Table of Contents

| | | |
|-----|--------------------------------------|-----|
| 1-1 | SCOPE OF MANUAL | 1-3 |
| 1-2 | INTRODUCTION | 1-3 |
| 1-3 | DESCRIPTION | 1-3 |
| 1-4 | IDENTIFICATION NUMBER | 1-5 |
| 1-5 | RELATED MANUALS | 1-5 |
| | GPIB Programming Manual | 1-5 |
| | SCPI Programming Manual | 1-5 |
| | Maintenance Manual | 1-5 |
| 1-6 | OPTIONS | 1-6 |
| 1-7 | PERFORMANCE SPECIFICATIONS | 1-6 |
| 1-8 | RECOMMENDED TEST EQUIPMENT | 1-7 |



Figure 1-1. Series 681XXB Synthesized Sweep Generator

Chapter 1

General Information

1-1 SCOPE OF MANUAL

This manual provides general information, installation, and operating information for the WILTRON Series 681XXB Synthesized Sweep Generator. (Throughout this manual, the terms *681XXB* and *sweep generator* will be used interchangeably to refer to the instrument.) Manual organization is shown in the table of contents.

1-2 INTRODUCTION

This chapter contains general information about the series 681XXB sweep generators. It includes a general description of the instrument and information on its identification number, related manuals, options, and performance specifications. A listing of recommended test equipment is also provided.

1-3 DESCRIPTION

The Series 681XXB Synthesized Sweep Generators are microprocessor-based, synthesized signal sources with high resolution phase-lock capability. They generate both broad (full range) and narrow band sweeps and discrete CW frequencies across the frequency range of 10 MHz to 40 GHz. All functions of the sweep generator are fully controllable locally from the front panel or remotely (except for power on/standby) via the IEEE-488 General Purpose Interface Bus (GPIB).

The series presently consists of six models covering a variety of frequency and power ranges. Table 1-1, on page 1-4, lists models, frequency ranges, and maximum leveled output.

Table 1-1. Series 681XXB Models

| 681XXB Model | Frequency (GHz) | Output Power | Output Power w/Optional Attenuator |
|--|------------------------|---------------------|---|
| 68137B | 2.0 – 20.0 GHz | +13 dBm | +11 dBm |
| 68147B | 0.01 – 20.0 GHz | +13 dBm | +11 dBm |
| 68153B | 2.0 – 20.0 GHz | +9 dBm | +7 dBm |
| | 20.0 – 26.5 GHz | +6 dBm | +3.5 dBm |
| 68159B | 0.01 – 2.0 GHz | +13 dBm | +11 dBm |
| | 2.0 – 20.0 GHz | +9 dBm | +7 dBm |
| | 20.0 – 26.5 GHz | +6 dBm | +3.5 dBm |
| 68163B | 2.0 – 20.0 GHz | +9 dBm | +7 dBm |
| | 20.0 – 40.0 GHz | +6 dBm | +3 dBm |
| 68169B | 0.01 – 2.0 GHz | +13 dBm | +11 dBm |
| | 2.0 – 20.0 GHz | +9 dBm | +7 dBm |
| | 20.0 – 40.0 GHz | +6 dBm | +3 dBm |
| With Option 15 (High Power) Installed | | | |
| 68137B | 2.0 – 20.0 GHz | +17 dBm | +15 dBm |
| 68147B | 0.01 – 2.0 GHz | +13 dBm | +11 dBm |
| | 2.0 – 20.0 GHz | +17 dBm | +15 dBm |
| 68153B | 2.0 – 20.0 GHz | +13 dBm | +11 dBm |
| | 20.0 – 26.5 GHz | +10 dBm | +7.5 dBm |
| 68159B | 0.01 – 2.0 GHz | +13 dBm | +11 dBm |
| | 2.0 – 20.0 GHz | +13 dBm | +11 dBm |
| | 20.0 – 26.5 GHz | +10 dBm | +7.5 dBm |
| 68163B | 2.0 – 20.0 GHz | +13 dBm | +11 dBm |
| | 20.0 – 40.0 GHz | +6 dBm | +3 dBm |
| 68169B | 0.01 – 2.0 GHz | +13 dBm | +11 dBm |
| | 2.0 – 20.0 GHz | +13 dBm | +11 dBm |
| | 20.0 – 40.0 GHz | +6 dBm | +3 dBm |

1-4 IDENTIFICATION NUMBER

All WILTRON instruments are assigned a unique six-digit ID number, such as "301001". The ID number is imprinted on a decal that is affixed to the rear panel of the unit. Special-order instrument configurations also have an additional *special* serial number tag attached to the rear panel of the unit.

When ordering parts or corresponding with WILTRON Customer Service, please use the correct serial number with reference to the specific instrument's model number (i.e., Model 68147B Synthesized Sweep Generator, Serial No. 301001).

1-5 RELATED MANUALS

This is one of a four manual set that consists of an Operation Manual, a GPIB Programming Manual, a SCPI Programming Manual, and a Maintenance Manual.

***GPIB
Programming
Manual***

This manual provides information for remote operation of the sweep generator with 681XXB Product Specific commands sent from an external controller via the IEEE 488 General Purpose Interface Bus (GPIB). It contains a general description of the GPIB and bus data transfer and control functions, a complete listing and description of all 681XXB GPIB Product Specific commands, and several programming examples. The WILTRON part number for the GPIB Programming Manual is 10370-10260.

***SCPI
Programming
Manual***

This manual provides information for remote operation of the sweep generator with Standard Commands for Programmable Instruments (SCPI) commands sent from an external controller via the IEEE 488 General Purpose Interface Bus (GPIB). It contains a general description of the GPIB and bus data transfer and control functions, a complete listing and description of each command in the 681XXB SCPI command set, and examples of command usage. The WILTRON part number for the SCPI Programming Manual is 10370-10274.

***Maintenance
Manual***

The Maintenance Manual supplies service information for all models in the 681XXB series. The service information includes functional circuit descriptions, block diagrams, performance verification tests, calibration procedures, troubleshooting data, and assembly and component removal/replacement procedures. The WILTRON part number for the Maintenance Manual is 10370-10262.

1-6 *OPTIONS*

The following options are available.

- Option 1, Rack Mounting.** Rack mount kit containing a set of track slides (90° tilt capability), mounting ears, and front panel handles for mounting the instrument in a standard 19-inch equipment rack.
- Option 2A, 110 dB Step Attenuator.** Adds a 10 dB per step attenuator with a 110 dB range for models having a high-end frequency of ≤ 26.5 GHz. Output power is selected directly in dBm on the front panel (or via GPIB). Rated RF output power is reduced.
- Option 2B, 110 dB Step Attenuator.** Adds a 10 dB per step attenuator with a 110 dB range for models having a high-end frequency of ≤ 40 GHz. Output power is selected directly in dBm on the front panel (or via GPIB). Rated RF output power is reduced.
- Option 9K, Rear Panel RF Output.** Adds an RF output connector (K-Connector[®], female) to the rear panel and deletes the RF output connector on the front panel.
- Option 11, 0.1 Hz Frequency Resolution.** Provides frequency resolution of 0.1 Hz.
- Option 14, WILTRON 360B VNA Compatibility.** Modifies rack mounting hardware to mate unit in a WILTRON 360B VNA console.
- Option 15, High Power Output.** Adds high-power RF components to the instrument providing 50 mW RF output power in the 2–26.5 GHz frequency range.
- Option 16, High-Stability Time Base.** Adds an ovenized, 10 MHz crystal oscillator with $< 5 \times 10^{-10}$ /day frequency stability.
- Option 17, No Front Panel.** Deletes the front panel for use in remote control applications where a front panel display or keyboard control are not needed.
- Option 19, SCPI Programmability.** Adds GPIB command mnemonics complying with Standard Commands for Programmable Instruments (SCPI), Version 1993.0. SCPI programming complies with IEEE 488.2-1987.

1-7 *PERFORMANCE
SPECIFICATIONS*

Series 681XXB Synthesized Sweep Generator performance specifications are provided in Appendix B.

K Connector[®] is a registered trademark of WILTRON Company.

**1-8 RECOMMENDED TEST
EQUIPMENT**

Table 1-2 lists the recommended test equipment for performing the Series 681XXB Synthesized Sweep Generator operation verification tests in Chapter 5.

Table 1-2. *Recommended Test Equipment*

| Instrument | Critical Specification | Recommended Manufacturer/Model |
|--|---|--|
| Frequency Counter, with External Mixer | <i>Range:</i> 0.01 to 40 GHz <i>Input Z:</i> 50Ω <i>Resolution:</i> 1 Hz <i>Other:</i> External Time Base Input | EIP Microwave, Inc. Model 578A, with External Mixer: Option 91 (26.5 to 40 GHz) |
| Power Meter, with Power Sensor | <i>Range:</i> -30 to +20 dBm (1μW to 100 mW) | Hewlett-Packard Model 437B, with Power Sensor: HP 8487A (0.01 to 50 GHz) |
| Oscilloscope | <i>Bandwidth:</i> DC to 150 MHz <i>Vertical Sensitivity:</i> 2 mV/division <i>Horiz Sensitivity:</i> 50 ns/division | Tektronix, Inc. Model 2445 |

Chapter 2

Installation

Table of Contents

| | | |
|-----|--|------|
| 2-1 | INTRODUCTION | 2-3 |
| 2-2 | INITIAL INSPECTION | 2-3 |
| 2-3 | PREPARATION FOR USE | 2-4 |
| | Power Requirements | 2-4 |
| | Line Voltage Selection | 2-4 |
| | Power Connection | 2-4 |
| | Standby Operation | 2-5 |
| | Warmup Time | 2-6 |
| | Operating Environment | 2-6 |
| 2-4 | GPIB SETUP AND INTERCONNECTION | 2-7 |
| | Interface Connector | 2-7 |
| | Cable Length Restrictions | 2-7 |
| | GPIB Interconnection | 2-7 |
| | Setting the GPIB Address | 2-7 |
| | Selecting the Line Terminator | 2-9 |
| | Selecting the Interface Language | 2-9 |
| 2-5 | PREPARATION FOR STORAGE/SHIPMENT | 2-10 |
| | Preparation for Storage | 2-10 |
| | Preparation for Shipment | 2-10 |

Chapter 2

Installation

2-1 INTRODUCTION

This chapter provides installation instructions for the Series 681XXB Synthesized Sweep Generator. It includes information on initial inspection, preparation for use, storage, and reshipment, and General Purpose Interface Bus (GPIB) setup and interconnections.

2-2 INITIAL INSPECTION

Inspect the shipping container for damage. If the shipping container or cushioning material is damaged, retain until the contents of the shipment have been checked against the packing list and the sweep generator has been checked for mechanical and electrical operation.

If the shipment is incomplete or if the sweep generator is damaged mechanically or electrically, notify your local sales representative or WILTRON Customer Service. If either the shipping container is damaged or the cushioning material shows signs of stress, notify the carrier as well as WILTRON. Keep the shipping materials for the carrier's inspection.

2-3 PREPARATION FOR USE

Preparation for use consists of checking that the rear panel line voltage selector switch is set for the correct line voltage and connecting the sweep generator to the power source. The following paragraphs provide these procedures along with information about power requirements, warmup times, and the operating environment.

Power Requirements The sweep generator accepts 90 to 132 Vac and 180 to 264 Vac, 48 to 400 Hz, single-phase power. Power consumption is 400 VA maximum.

Line Voltage Selection The line voltage selector switch on the rear panel can be set for either 110 Vac or 220 Vac operation (Figure 2-1). When the switch is set to 110 Vac, the 681XXB accepts 90 to 132 Vac line voltage. When the switch is set to 220 Vac, the 681XXB accepts 180 to 264 Vac line voltage. If the selector setting is incorrect for the line voltage available, change it to the correct setting.

Whenever the selector setting is changed, the line fuse must be changed to the correct value for the line voltage selected. Line fuse values for the line voltages are printed on the rear panel next to the fuse holder.

CAUTION

To avoid possible equipment damage, the instrument cabinet should be grounded. **Always** use a three-wire power cable connected to a three-wire power line outlet to power the 681XXB.

Power Connection Connecting the 681XXB to line power automatically places it in operation (front panel OPERATE LED on). To connect it to the power source, plug the female end of the power cable into the input line voltage receptacle on the rear panel (Figure 2-1). Then plug the male end of the power cord into a three-wire power line outlet.

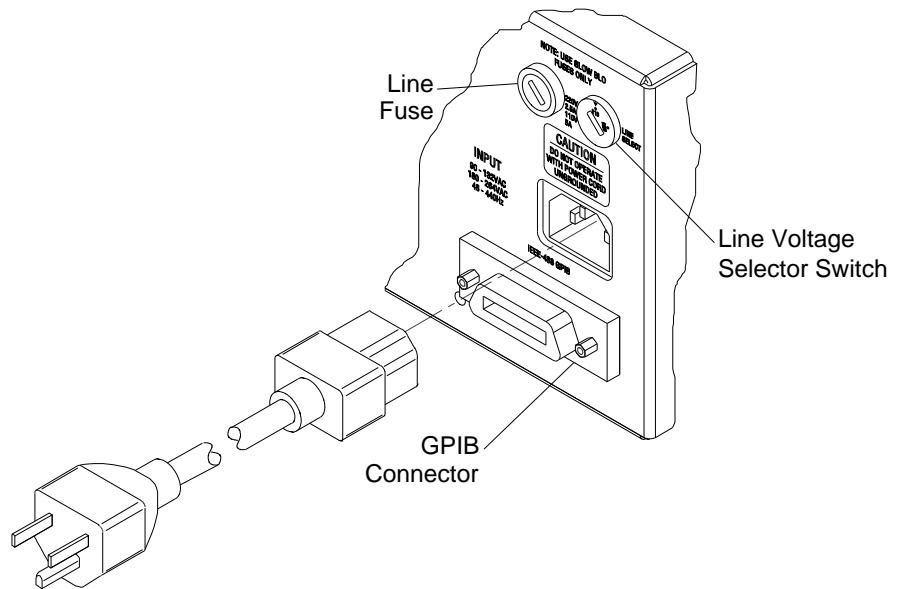
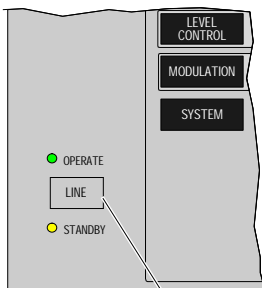

Figure 2-1. Sweep Generator Rear Panel showing Power Connection



Line Key

Standby Operation

Whenever the sweep generator is not being used it should be left connected to the power source and placed in standby. This keeps the internal timebase frequency reference at operating temperature.

On the front panel, press **LINE** to switch the 681XXB from OPERATE (green LED on) to STANDBY (orange LED on).

NOTE

During standby operation, the fan runs continuously.

***Warmup
Time***

From a cold start (ac power application), the sweep generator requires approximately 120 hours (5 days) of warm up to achieve 1×10^{-7} /day frequency accuracy and stability.

If the Option 16 time base is installed, the 681XXB requires approximately 72 hours (3 days) of warm up to achieve 5×10^{-10} /day frequency accuracy and stability.

When placing the 681XXB in operation from stand-by, allow 30 minutes warmup to assure stable operation.

***Operating
Environment***

The 681XXB can be operated within the following environmental limits.

- Temperature.** 0°C to 55°C (-32°F to 131°F).
- Humidity.** 5 to 95% relative at 40°C.
- Altitude.** up to 4600 meters (approximately 15,000 feet).
- Cooling.** Internal cooling is provided by forced airflow from the fan mounted on the rear panel.

CAUTION

Before installing the 681XXB in its operating environment, ensure that all airflow passages at the sides and rear of the instrument are clear. This is of particular importance whenever the instrument is being rack-mounted.

**2-4 GPIB SETUP AND
INTERCONNECTION**

The 681XXB provides automated microwave signal generation via the GPIB. The following paragraphs provide information about interface connections, cable requirements, setting the GPIB operating parameters, and selecting the external interface language.

**Interface
Connector**

Interface between the sweep generator and other devices on the GPIB is via a 24-wire interface cable. This cable uses connector shells having two connector faces. These double-faced connectors allow for the parallel connection of two or more cables to a single device. Figure 2-1 shows the location of the rear panel GPIB connector.

**Cable Length
Restrictions**

The GPIB can accommodate up to 15 instruments at any one time. To achieve design performance on the bus, proper timing and voltage level relationships must be maintained. If either the cable length between separate instruments or the cumulative cable length between all instruments is too long, the data and control lines cannot be driven properly and the system may fail to perform. Cable length restrictions are as follows:

- No more than 15 instruments may be installed on the bus.
- Total cumulative cable length in meters may not exceed two times the number of bus instruments or 20 meters—whichever is less.

NOTE

For low EMI applications, the GPIB cable should be a fully shielded type, with well-grounded metal-shell connectors

**GPIB Inter-
connection**

The only interconnection required for GPIB operation is between the sweep generator and the controller. This interconnection is via a standard GPIB cable. The WILTRON Part number for such a cable is 2000-1, -2, or -4 (1, 2, or 4 meters in length).

**Setting the
GPIB
Address**

The default GPIB address is 5. If a different GPIB address is desired, it can be set from the front panel using the Configure GPIB Menu.

To change the GPIB address, first press the front panel main menu key labeled **SYSTEM**. The System Menu (shown on the following page) is displayed.

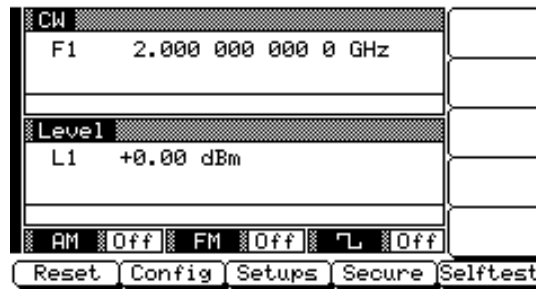

Now press the menu soft-key **Config** . The System Configuration Menu (shown below) is displayed.

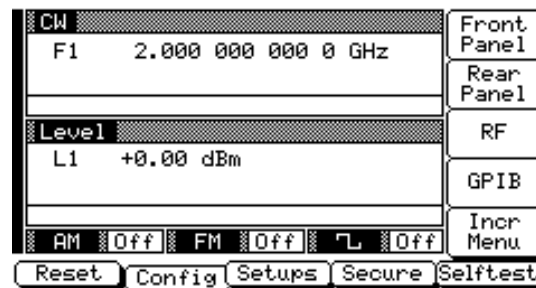

To go to the Configure GPIB menu from this menu, press the menu soft-key **GPIB** . The Configure GPIB Menu (shown below) is displayed.

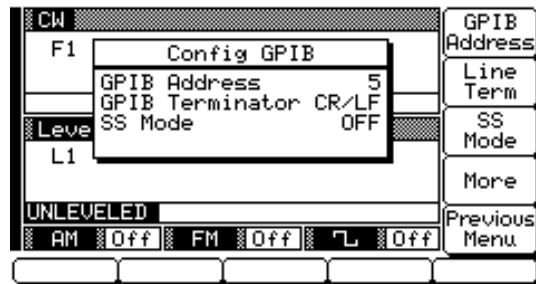

Press the menu soft-key **GPIB Address** to change the current GPIB address of the sweep generator. Enter a new address using the cursor control key or the data entry keypad and the terminator key



The new GPIB address will now appear on the display. The entry must be between 1 and 30 to be recognized as a valid GPIB address.

Selecting the Line Terminator

Data is delimited on the GPIB by either the carriage return (CR) ASCII character or both the carriage return and line feed (CR/LF) ASCII characters. Which character is used depends upon the requirements of the system controller. Most modern controllers can use either CR or CR/LF, while many older controllers require one or the other. Consult the controller's manual for its particular requirements.

From the Configure GPIB Menu display, you can select which GPIB terminator to use by pressing the menu soft-key **Line Term**. This menu soft-key toggles the GPIB terminator between CR and CR/LF. The current selection appears on the display.

Selecting the Interface Language

Series 681XXB Synthesized Sweep Generators can be remotely operated via the GPIB using one of two external interface languages—Native or SCPI (Option 19). The Native interface language uses a set of 681XXB GPIB Product Specific commands to control the instrument; the SCPI interface language uses a set of the Standard Commands for Programmable Instruments commands to control the unit.

The Configure GPIB Menu has an additional menu display. For instruments with Option 19, selection of which external interface language is to be used is made from this additional menu. From the Configure GPIB Menu display, you can access the additional menu by pressing **More**. The additional Configure GPIB Menu (shown below) is displayed.

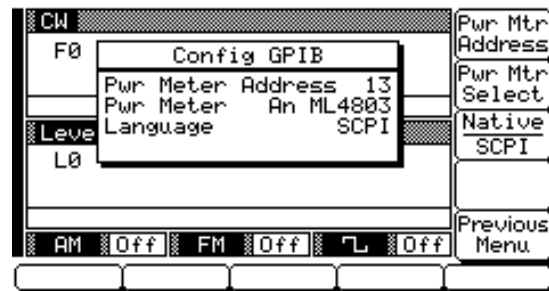

Press **Native SCPI** to select the external interface language to be used. This menu soft-key toggles the language selection between Native and SCPI. The current selection appears on the display.

**2-5 PREPARATION FOR
STORAGE/SHIPMENT**

The following paragraphs give instructions for preparing the 681XXB for storage or shipment.

***Preparation
for Storage***

Preparing the sweep generator for storage consists of cleaning the unit, packing the inside with moisture-absorbing desiccant crystals, and storing the unit in a temperature environment that is maintained between -40°C and $+75^{\circ}\text{C}$ (-40°F to $+176^{\circ}\text{F}$).

***Preparation
for Shipment***

To provide maximum protection against damage in transit, the sweep generator should be repackaged in the original shipping container. If this container is no longer available and the unit is being returned to WILTRON for repair, advise WILTRON Customer Service; they will send a new shipping container free of charge. In the event neither of these two options is possible, instructions for packaging and shipment are given below.

Use a Suitable Container.

Obtain a corrugated cardboard carton with a 275-pound test strength. This carton should have inside dimensions of no less than six inches larger than the unit dimensions to allow for cushioning.

Protect the Instrument.

Surround the unit with polyethylene sheeting to protect the finish.

Cushion the Instrument.

Cushion the instrument on all sides by tightly packing dunnage or urethane foam between the carton and the unit. Provide at least three inches of dunnage on all sides.

Seal the Container.

Seal the carton by using either shipping tape or an industrial stapler.

Address the Container.

If the instrument is being returned to WILTRON for service, mark the address of the appropriate WILTRON service center (Table 2-1) and your return address on the carton in one or more prominent locations.

Table 2-1. WILTRON Service Centers**UNITED STATES**

WILTRON COMPANY
490 Jarvis Drive
Morgan Hill, CA 95037-2809
Telephone: (408) 778-2000
Telex: 285227 WILTRON MH
FAX: (408) 778-0239

**ANRITSU WILTRON SALES
COMPANY**

685 Jarvis Drive
Morgan Hill, CA 95037-2809
Telephone: (408) 776-8300
FAX: (408) 776-1744

**ANRITSU WILTRON SALES
COMPANY**

10 Kingsbridge Road
Fairfield, NJ 07004
Telephone: (201) 227-8999
FAX: (201) 575-0092

AUSTRALIA

WILTRON PTY. LTD.
Level 2, 410 Church Street
North Parramatta
NSW 2151 Australia
Telephone: 026-30-81-66
Fax: 026-83-68-84

BRAZIL

ANRITSU WILTRON ELEC-
TRONICA LTDA.
Praia de Botafogo, 440-SL 2401-Bo-
tafogo
2225-Rio de Janeiro-RJ-Brasil
Telephone: 021-28-69-141
Fax: 021-53-71-456

CANADA

ANRITSU WILTRON INSTRU-
MENTS LTD.
215 Stafford Road, Unit 102
Nepean, Ontario K2H 9C1
Telephone: (613) 828-4090
FAX: (613) 828-5400

CHINA

WILTRON BEIJING SERVICE
CENTER
416W Beijing Fortune Building
5 Dong San Huan Bei Lu
Chao Yang Qu, Beijing 100004,
China
Telephone: 86-1-50-17-559
FAX: 86-1-50-17-558

FRANCE

ANRITSU WILTRON S.A
9 Avenue du Quebec
Zone de Courtaboeuf
91951 Les Ulis Cedex
Telephone: 016-44-66-546
FAX: 016-44-61-065

GERMANY

ANRITSU WILTRON GmbH
Rudolf Diesel Strabe 17
8031 Gilching
Telephone: 08-10-58-055
FAX: 08-10-51-700

INDIA

MEERA AGENCIES (P) LTD.
A-23 Hauz Khas
New Delhi 110 016
Telephone: 011-685-3959
FAX: 011-686-6720

ISRAEL

TECH-CENT, LTD
Haarad St. No. 7, Ramat Haahayal
Tel-Aviv 69701
Telephone: (03) 64-78-563
FAX: (03) 64-78-334

ITALY

ANRITSU WILTRON Sp.A
Roma Office
Via E. Vittorini, 129
00144 Roma EUR
Telephone: (06) 50-22-666
FAX: (06) 50-22-4252

JAPAN

ANRITSU CORPORATION
1800 Onna Atsugi-shi
Kanagawa-Prf. 243 Japan
Telephone: 0462-23-1111
FAX: 0462-25-8379

KOREA

WILTRON CORPORATION
#2103 Korea World Trade Center
159-1 Samsung-Dong
Kangnam-ku, Seoul
Telephone: (02) 551-2250
FAX: (02) 551-4941

SWEDEN

ANRITSU WILTRON AB
Box 247
S-127 25 Skarholmen
Telephone: (08) 74-05-840
FAX: (08) 71-09-960

TAIWAN

WILTRON CO., LTD.
8F, No. 96, Section 3
Chien Kuo N. Road
Taipei, Taiwan, R.O.C.
Telephone: (02) 515-6050
FAX: (02) 509-5519

UNITED KINGDOM

ANRITSU WILTRON LTD.
200 Capability Green
Luton, Bedfordshire
LU1 3LU, England
Telephone: 05-82-41-88-53
FAX: 05-82-31-303

Chapter 3

Local (Front Panel) Operation

Table of Contents

| | | |
|-----|---|------|
| 3-1 | INTRODUCTION | 3-3 |
| 3-2 | FRONT PANEL LAYOUT | 3-4 |
| | Line Key | 3-4 |
| | Data Display Area | 3-4 |
| | Data Entry Area | 3-5 |
| | RF Output Control Key | 3-5 |
| | Connectors | 3-5 |
| 3-3 | DATA DISPLAY AREA | 3-6 |
| | Menu Display Format | 3-7 |
| | Menu Keys | 3-8 |
| 3-4 | DATA ENTRY AREA | 3-10 |
| 3-5 | INSTRUMENT START-UP | 3-12 |
| | Powering Up the 681XXB | 3-12 |
| | Start-Up Display | 3-12 |
| | Standby Operation | 3-12 |
| | Self-Testing the 681XXB | 3-13 |
| | Resetting to Default Parameters | 3-13 |
| 3-6 | ENTERING DATA | 3-15 |
| | Opening the Parameter | 3-15 |
| | Editing the Current Value | 3-16 |
| | Entering a New Value | 3-17 |
| 3-7 | CW FREQUENCY OPERATION | 3-18 |
| | Selecting CW Mode | 3-18 |
| | Selecting a CW Frequency | 3-18 |

| | | |
|------|--|-------------|
| | Selecting a Power Level | 3-20 |
| | CW Ramp | 3-21 |
| 3-8 | SWEEP FREQUENCY OPERATION | 3-22 |
| | Selecting Analog Sweep Mode | 3-22 |
| | Setting the Analog Sweep Time | 3-23 |
| | Selecting a Sweep Trigger | 3-24 |
| | Selecting Step Sweep Mode | 3-25 |
| | Setting Step Size and Dwell Time | 3-26 |
| | Selecting Manual Sweep Mode | 3-27 |
| | Selecting a Sweep Range | 3-28 |
| | Selecting a Power Level | 3-30 |
| | Frequency Markers | 3-31 |
| | Selecting Alternate Sweep Mode | 3-33 |
| 3-9 | FIXED POWER LEVEL OPERATION | 3-36 |
| | Selecting Fixed Power Level Mode | 3-36 |
| | Selecting a Power Level | 3-36 |
| | Level Offset | 3-39 |
| 3-10 | POWER LEVEL SWEEP OPERATION | 3-40 |
| | Selecting CW Power Sweep Mode | 3-40 |
| | Setting CW Power Sweep Step Size and Dwell Time | 3-41 |
| | Selecting a CW Power Sweep Trigger | 3-42 |
| | Selecting a Power Level Sweep Range | 3-43 |
| | Selecting a Sweep Frequency / Step Power Mode | 3-45 |
| | Setting Power Level Step Size | 3-46 |
| 3-11 | LEVELING OPERATIONS | 3-47 |
| | Selecting a Leveling Mode | 3-47 |
| | Attenuator Decoupling | 3-51 |
| | ALC Power Slope | 3-52 |
| | User Cal (User Level Flatness Correction) | 3-54 |
| 3-12 | SIGNAL MODULATION | 3-60 |
| | Amplitude Modulation Operating Modes | 3-60 |
| | Providing Amplitude Modulation | 3-60 |
| | Frequency Modulation Operating Modes | 3-62 |
| | Providing Frequency Modulation | 3-62 |
| | Square Wave Modulation Operating Modes | 3-64 |
| | Providing Square Wave Modulation | 3-64 |

| | | |
|------|---------------------------------------|------|
| 3-13 | SYSTEM CONFIGURATION | 3-67 |
| | Configuring the Front Panel | 3-68 |
| | Configuring the Rear Panel | 3-69 |
| | Configuring the RF | 3-70 |
| | Configuring the GPIB | 3-71 |
| | Setting Increment Sizes | 3-73 |
| 3-14 | SAVING/RECALLING INSTRUMENT SETUPS . | 3-74 |
| | Saving Setups | 3-74 |
| | Recalling Setups | 3-74 |
| | Erasing Stored Setups | 3-75 |
| 3-15 | SECURE OPERATION | 3-76 |

Chapter 3

Local (Front Panel) Operation

3-1 INTRODUCTION

This chapter provides information and instructions on operating the Series 681XXB Synthesized Sweep Generator using the front panel controls. It contains the following:

- Illustrations and diagrams of the front panel, data display area, and data entry area that identify and describe all front panel controls, inputs, and outputs.
- An annotated diagram of the menu display format showing where the current frequency, power, and modulation information is displayed.
- Instructions for performing sweep generator operations; namely, frequency and frequency sweep, power level and power sweep, signal modulation, saving and recalling instrument setups, and system configuration.

3-2 FRONT PANEL LAYOUT

The 681XXB front panel is divided into two main areas—the data display area and the data entry area. The following paragraphs provide a brief description of the front panel controls, inputs, outputs, and data display and data entry areas as shown in Figure 3-1. Detailed descriptions of the data display and data entry areas are contained in paragraphs 3-3 and 3-4.

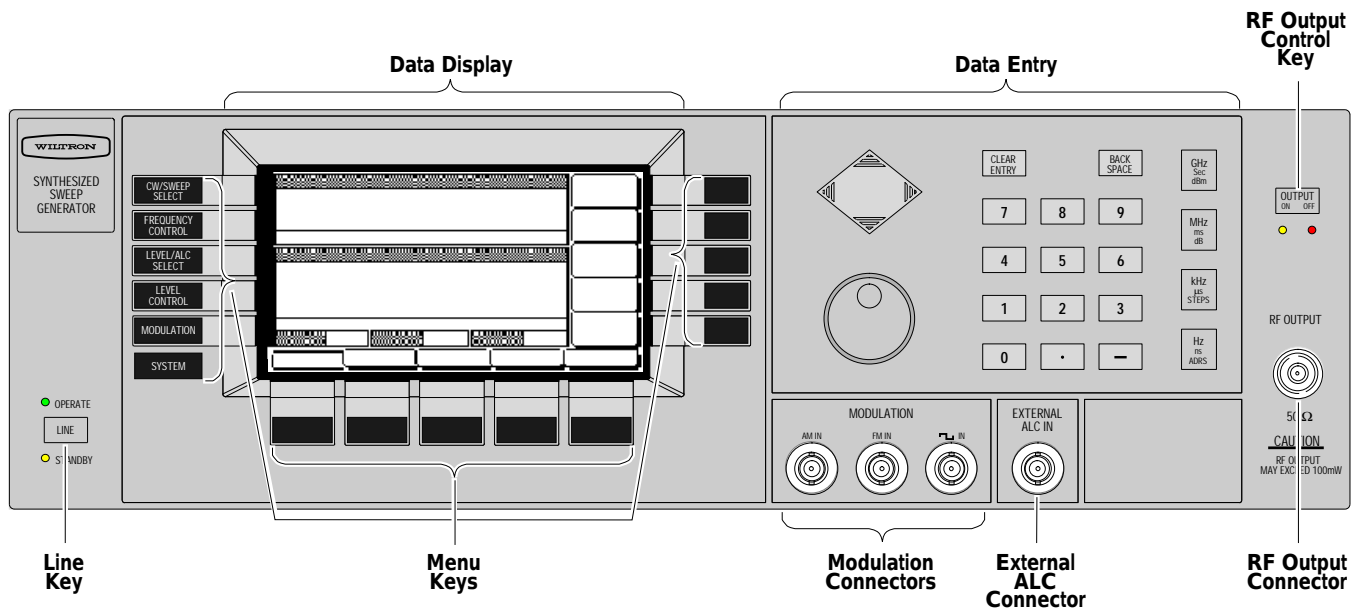

Figure 3-1. Front Panel, 681XXB Synthesized Sweep Generator

Line Key

The line key provides for turning the sweep generator on and off. STANDBY (off) is indicated by an orange LED; OPERATE (on) by a green LED.

Data Display Area

The data display area consists of the data display and the surrounding menu keys.

Data Display

The data display provides information about the current status of the 681XXB in a menu display format. This information includes the operating mode of the instrument, the value of the active frequency and power level parameters, and the modulation status.

Menu Keys

Menu keys provide for selecting the operating mode, parameters, and configuration of the sweep generator.

**Data
Entry Area**

The data entry area consists of data entry keys and controls that provide for (1) changing values for each 681XXB parameter, and (2) terminating the value entry and assigning the appropriate units (GHz, MHz, dBm, etc.).

**RF Output
Control Key**

The RF output control key provides for turning the RF output power on and off. OUTPUT OFF is indicated by a red LED; OUTPUT ON by a yellow LED.

Connectors

The front panel has both input and output connectors.

Modulation Connectors

The modulation connectors provide for applying external AM, FM, or Square Wave modulation to the RF output signal.

External ALC Connector

The external ALC connector provides for leveling the RF output signal externally using either a detector or a power meter.

RF Output Connector

The RF output connector provides RF output from a 50Ω source.

NOTE

To prevent power losses due to an impedance mismatch, the mating connector and cable should also be rated at 50Ω.

3-3 DATA DISPLAY AREA

The data display area consists of the data display and the surrounding menu keys. The data display is a dot matrix liquid crystal display (LCD) that provides 16 lines of 40 characters each. Information is presented on the LCD in the form of menu displays. The menu keys either select the main menu to be displayed, select a sub-menu of the current menu display, or control a function on the current menu display.

Figure 3-2 shows the format of the menu display and identifies the display elements. It also shows the placement of the menu keys in relation to the display. The paragraphs that follow provide descriptions of the menu display elements and the menu keys.

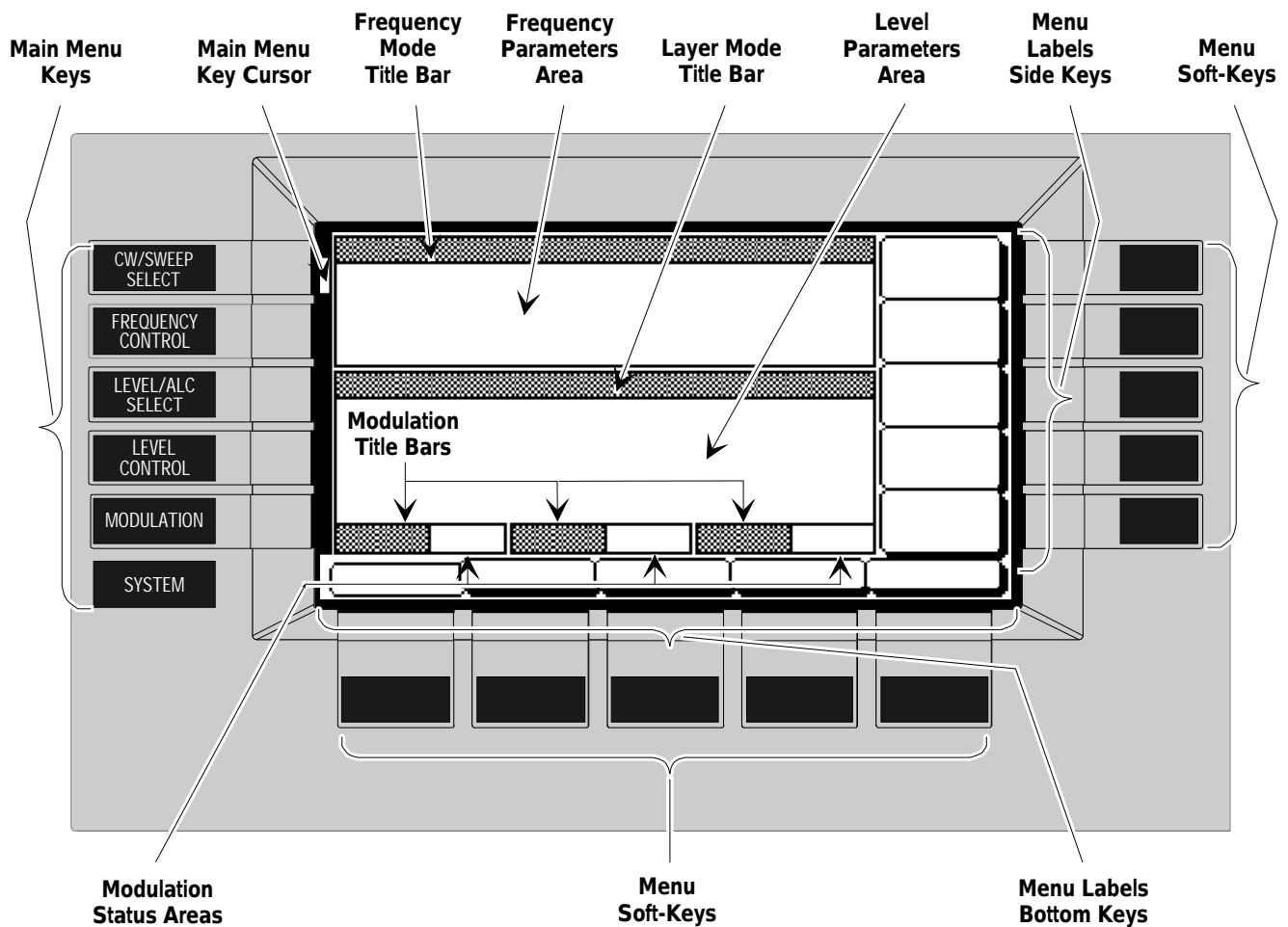

Figure 3-2. Front Panel Data Display Area

**Menu
Display
Format**

The menu display is divided into specific areas that show the frequency, power level, and modulation information for the current sweep generator setup. Menu labels for the current menu's soft-keys appear along the bottom and right side of the display.

Title Bars

A shaded title bar identifies each parameter area. Mode information is displayed in reverse video on the title bars.

- **Frequency Mode Title Bar**—The current frequency mode (CW, Analog Sweep, Step Sweep, or Manual Sweep) appears on the left side of the bar. In an analog or step sweep mode, the type of sweep trigger (Auto, Extern, or Single) appears on the right side.
- **Level Mode Title Bar**—The current power level mode (Level or Level Sweep) appears on the left side of the bar. In a level sweep mode, the type of sweep trigger (Auto, External, or Single) appears on the right side of the bar.
- **Modulation Title Bars**—Each type of signal modulation (AM, FM, Square Wave) has a separate title bar on the display.

Parameter Areas

The parameter areas show the frequency, power level, and modulation information for the current 681XXB setup.

- **Frequency Parameters Area**—The current CW frequency in GHz, or the start and stop frequencies of the current frequency sweep range in GHz are displayed in this area.
- **Power Level Parameters Area**—The current power level in dBm, or the start and stop levels of the current power level sweep range in dBm are displayed in this area.
- **Modulation Status Areas**—These areas display ON or OFF to indicate the status of signal modulation for the current setup.

Menu Labels

Each of the menu soft-keys, located below and to the right of the display, has a corresponding menu label area on the display. These labels identify the function of the soft-keys for the current menu display. In most cases, when a menu soft-key is pressed, its menu label changes appearance to visually show the On/Off condition.

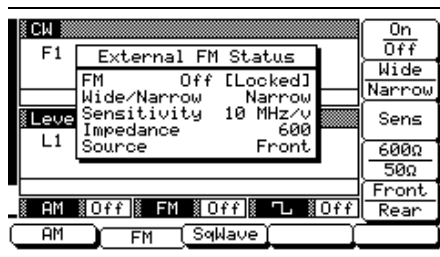

Window Display

A window display that overlays a portion of the current menu display is used to (1) show the parameter being edited; (2) display selection lists of preset frequencies, power levels, markers, etc.; (3) show the modulation and system configuration choices and current selections; or (4) show self-test error messages. A typical window display is shown on the left.

Menu Keys

As shown in Figure 3-2, there are two types of menu keys that surround the data display—main menu keys and menu soft-keys. The main menu keys are positioned to the left of the data display. The menu soft-keys are located at the bottom and to the right of the data display.

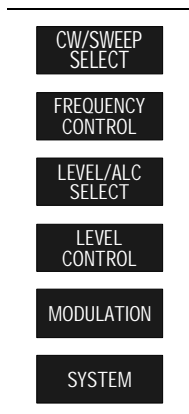

Main Menu Keys

Each of the main menu keys, shown on the left, selects a main (top-level) menu display. These menus let you select the operating mode, operating parameters, and configuration of the instrument. A brief functional description of each main menu follows.

- **CW/SWEEP SELECT**—This menu lets you select between CW, Analog, Step, and Manual Sweep frequency modes.
- **FREQUENCY CONTROL**—In CW frequency mode, this menu lets you select the CW frequency parameter (F0-F9 or M0-M9) to use. In the Analog, Step, or Manual Sweep frequency mode, this menu lets you select the sweep range parameters (Full, F1-F2, F3-F4, F5-dF, or F6-dF) to use. In Analog or Step Sweep frequency mode, the menu also lets you select up to 20 independent, pre-settable frequency markers.
- **LEVEL/ALC SELECT**—This menu lets you select power level and ALC modes (Level, Level Sweep, Level Offset, ALC on or off, internal or external ALC, ALC/attenuator decoupling, ALC slope, and user level flatness correction).
- **LEVEL CONTROL**—In Level mode, this menu lets you select the level parameter (L0-L9) to use for a CW frequency or a frequency sweep. In the Level Sweep mode, this menu lets you select the power sweep range parameters to use.

- **MODULATION**—This menu provides you with access to sub-menus that let you select the type of signal modulation (AM, FM, or Square Wave) and control the option settings for each type.
- **SYSTEM**—This menu provides you with access to sub-menus that let you (1) reset the instrument to factory-selected default values; (2) configure the front panel, rear panel, RF, and GPIB; (3) set incremental sizes for editing frequency, power level, and time parameters; (4) save or recall instrument setups; (5) disable front panel data display; and (6) perform instrument self-test.

Main Menu Key Cursor

With the exception of the **SYSTEM** key, when any main menu key is pressed, the main menu that is displayed contains a cursor positioned adjacent to the pressed key (Figure 3-2). The cursor is displayed on all sub-menus of the current menu until a different main menu key is pressed.

When the **SYSTEM** key is pressed, the System menu is displayed. The System menu and its sub-menus do *not* contain a main menu key cursor.

Menu Soft-Keys

As shown on the left, five menu soft-keys are located below the data display and five menu soft-keys are located to the right of the data display. In general, the menu soft-keys located below the data display select a sub-menu of the current main (top-level) menu display; the menu soft-keys located to the right of the data display either control a function on the current menu display or select an additional sub-menu. Menu labels that identify the current function of each soft-key are shown on the menu display adjacent to the soft-keys.

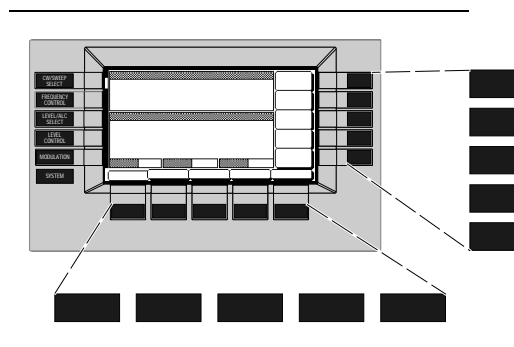

3-4 DATA ENTRY AREA

The value of a selected 681XXB parameter can be changed using the rotary data knob and/or keys of the data entry area. Each element of the data entry area is identified in Figure 3-3 and described in the following paragraphs.

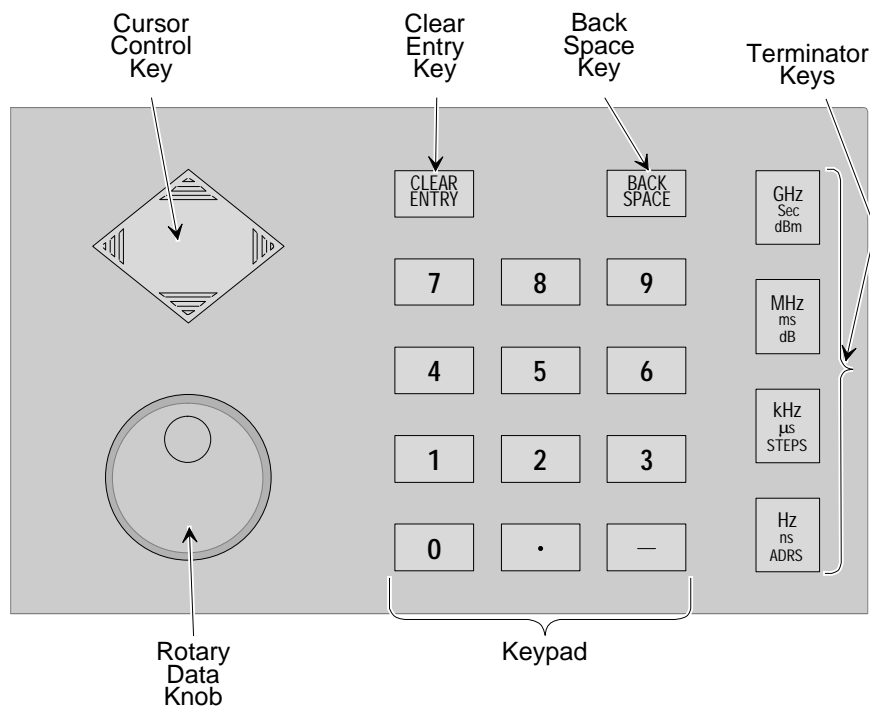

Figure 3-3. Front Panel Data Entry Area

Cursor Control Key

In general, this diamond-shaped key controls the movement of the cursor on the display. When a parameter is opened for editing, a cursor appears under the open parameter. Each time the < or > pad is pressed, the cursor moves left or right by one digit. The \wedge or \vee pad can then be used to increase or decrease the value of the parameter. The unit size of the increase or decrease that occurs each time the \wedge or \vee pad is pressed is determined by the cursor position.

In addition, when editing frequency, power level, and time parameters, the incremental size can be set to a specific value using a system configuration sub-menu. Once set and activated, each time the \wedge or \vee pad is pressed, the parameter's value increases or decreases by the set amount.

Rotary Data Knob

The rotary data knob can be used to change the value of a parameter that is open for editing. The cursor is moved under the open parameter using the < and > pads of the cursor control key. Then, by slowly turning the knob clockwise or counter-clockwise the value of the parameter is increased or decreased by the unit size. The unit size is determined by the cursor placement. Turning the knob rapidly changes the value of the parameter in larger steps.

When editing frequency, power level, and time parameters, the incremental size can be set to a specific value using a system configuration sub-menu. Once set and activated, each time the knob is turned clockwise or counter-clockwise, the parameter's value increases or decreases by the set amount.

KEYPAD

The numeric keypad provides for entering frequency, power level, time, and number-of-steps parameters and GPIB address values. The “-” key functions as a “change sign” key during any keypad entry.

CLEAR ENTRY Key

When a parameter is open for editing, the CLEAR ENTRY key is used to clear the parameter entry.

BACK SPACE Key

The BACK SPACE key is used to correct keypad data entry errors by deleting the last number, “-”, or decimal point entered.

Terminator Keys

The terminator keys are used to terminate keypad data entries and change the parameter values in memory. If the entered value is outside the allowable range of the open parameter, an error message will be displayed along with an audible “beep”. The terminator keys are as follows:

GHz / Sec / dBm
MHz / ms / dB
kHz / μ s / STEPS
Hz / ns / ADRS

3-5 INSTRUMENT START-UP

Now that you have familiarized yourself with the layout of the sweep generator's front panel controls and data display, you are ready to begin operating the instrument. Begin by powering it up.

**Powering Up
the 681XXB**

Connect the 681XXB to an ac power source by following the procedure in the Installation chapter. This automatically places the instrument in operation (front panel OPERATE LED on).

**Start-Up
Display**

During power up, the start-up display (shown below) appears on the data display. It provides you with the revision level of the installed firmware and informs you that instrument is loading programs. The start-up display remains displayed until the sweep generator has loaded all programs.

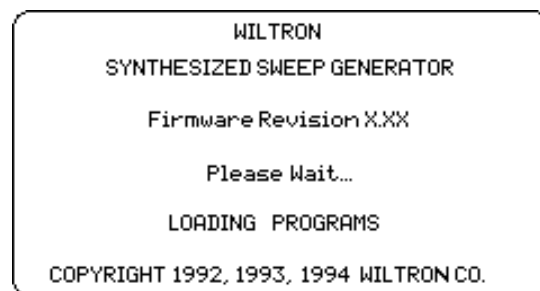

Upon completion of power up, the 681XXB returns to the exact configuration it was in when last turned off.

**Standby
Operation**

Whenever the sweep generator is not being used, it should be left connected to the power source and placed in standby. Standby operation provides power to keep the internal time base at operating temperature. This assures specified frequency accuracy and stability when the 681XXB is placed in operation.

NOTE

During standby operation, the fan runs continuously.

Press **LINE** to switch the 681XXB from OPERATE (green LED on) to STANDBY (orange LED on).

NOTE

When switching to operate from standby, allow at least a *30-minute warmup* before beginning sweep generator operations.

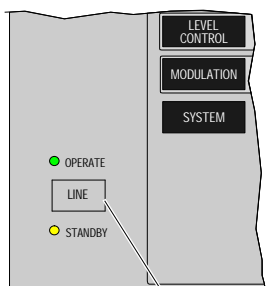

***Self-Testing
the 681XXB***

The 681XXB firmware includes internal diagnostics that self-test the instrument. These self-test diagnostics perform a brief go/no-go test of most of the PCBs and other internal assemblies. If the sweep generator fails self-test, an error message is displayed on the data display. Error messages and descriptions are listed in the Operator Maintenance chapter of this manual.

You can perform a self-test of the sweep generator at any time during normal operation. To perform a self-test from any menu, press **SYSTEM**. Then, when the System Menu (shown below) is displayed, press **Selftest**.

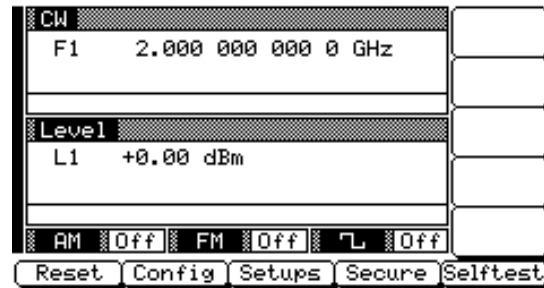

***Resetting to
Default Pa-
rameters***

You can reset the 681XXB to the factory-selected default parameter values at any time during normal operation. The default parameters are shown in Table 3-1 on the following page.

NOTE

Resetting the instrument clears the setup presently in place. If these parameter values are needed for future testing, save them as a stored setup before resetting the sweep generator.

To reset the sweep generator, press **SYSTEM**. When the System Menu (shown above) is displayed, press **Reset**.

Table 3-1. Reset (Default) Parameters

| 681XXB MODEL NUMBER | FREQUENCY PARAMETERS (GHz) | | | | | | | | | | | | | | | | | | | | |
|---------------------------|----------------------------|-----|------|-----|-----|-----|------|------|------|------|-----|-----|------|-----|-----|-----|------|------|------|------|-----|
| | F0 | F1 | F2 | F3 | F4 | F5 | F6 | F7 | F8 | F9 | M0 | M1 | M2 | M3 | M4 | M5 | M6 | M7 | M8 | M9 | ΔF |
| 68137B | 3.5 | 2.0 | 20.0 | 2.0 | 5.0 | 8.0 | 11.0 | 14.0 | 17.0 | 20.0 | 3.5 | 2.0 | 20.0 | 2.0 | 5.0 | 8.0 | 11.0 | 14.0 | 17.0 | 20.0 | 1.0 |
| 68147B | 3.5 | 2.0 | 20.0 | 2.0 | 5.0 | 8.0 | 11.0 | 14.0 | 17.0 | 20.0 | 3.5 | 2.0 | 20.0 | 2.0 | 5.0 | 8.0 | 11.0 | 14.0 | 17.0 | 20.0 | 1.0 |
| 68153B | 3.5 | 2.0 | 26.5 | 2.0 | 5.0 | 8.0 | 11.0 | 14.0 | 17.0 | 20.0 | 3.5 | 2.0 | 26.5 | 2.0 | 5.0 | 8.0 | 11.0 | 14.0 | 17.0 | 20.0 | 1.0 |
| 68159B | 3.5 | 2.0 | 26.5 | 2.0 | 5.0 | 8.0 | 11.0 | 14.0 | 17.0 | 20.0 | 3.5 | 2.0 | 26.5 | 2.0 | 5.0 | 8.0 | 11.0 | 14.0 | 17.0 | 20.0 | 1.0 |
| 68163B | 3.5 | 2.0 | 40.0 | 2.0 | 5.0 | 8.0 | 11.0 | 14.0 | 17.0 | 20.0 | 3.5 | 2.0 | 40.0 | 2.0 | 5.0 | 8.0 | 11.0 | 14.0 | 17.0 | 20.0 | 1.0 |
| 68169B | 3.5 | 2.0 | 40.0 | 2.0 | 5.0 | 8.0 | 11.0 | 14.0 | 17.0 | 20.0 | 3.5 | 2.0 | 40.0 | 2.0 | 5.0 | 8.0 | 11.0 | 14.0 | 17.0 | 20.0 | 1.0 |

| 681XXB MODEL NUMBER | POWER LEVEL PARAMETERS (dBm) | | | | | | | | | |
|---------------------------|------------------------------|-----|------|------|------|------|------|------|------|------|
| | L0 | L1 | L2 | L3 | L4 | L5 | L6 | L7 | L8 | L9 |
| 68137B | +1.0 | 0.0 | -1.0 | -2.0 | -3.0 | -4.0 | -5.0 | -6.0 | -7.0 | -8.0 |
| 68147B | +1.0 | 0.0 | -1.0 | -2.0 | -3.0 | -4.0 | -5.0 | -6.0 | -7.0 | -8.0 |
| 68153B | +1.0 | 0.0 | -1.0 | -2.0 | -3.0 | -4.0 | -5.0 | -6.0 | -7.0 | -8.0 |
| 68159B | +1.0 | 0.0 | -1.0 | -2.0 | -3.0 | -4.0 | -5.0 | -6.0 | -7.0 | -8.0 |
| 68163B | +1.0 | 0.0 | -1.0 | -2.0 | -3.0 | -4.0 | -5.0 | -6.0 | -7.0 | -8.0 |
| 68169B | +1.0 | 0.0 | -1.0 | -2.0 | -3.0 | -4.0 | -5.0 | -6.0 | -7.0 | -8.0 |

| 681XXB MODEL NUMBER | SWEEP TIME | STEP SWEEP | | LEVEL SWEEP | | LEVEL OFFSET |
|---------------------------|---------------|------------|--------------------|-------------|--------------------|-----------------|
| | | DWELL TIME | NUMBER OF STEPS | DWELL TIME | NUMBER OF STEPS | |
| 68137B | 50 ms | 50 ms | 50 | 50 ms | 50 | 0.0 dB |
| 68147B | 50 ms | 50 ms | 50 | 50 ms | 50 | 0.0 dB |
| 68153B | 50 ms | 50 ms | 50 | 50 ms | 50 | 0.0 dB |
| 68159B | 50 ms | 50 ms | 50 | 50 ms | 50 | 0.0 dB |
| 68163B | 50 ms | 50 ms | 50 | 50 ms | 50 | 0.0 dB |
| 68169B | 50 ms | 50 ms | 50 | 50 ms | 50 | 0.0 dB |

3-6 ENTERING DATA

Before proceeding to the various modes of sweep generator operation, you need to know how to enter data from the front panel. Entering data refers to changing a parameter's value by editing its current value or entering a new value to replace the current value. The following instructions describe how to (1) open a parameter, (2) edit its current value, and (3) enter a new value.

A typical 681XXB menu display (shown below) is used throughout the data entry instructions. At this menu display, you can edit both the CW frequency and the output power level parameters.

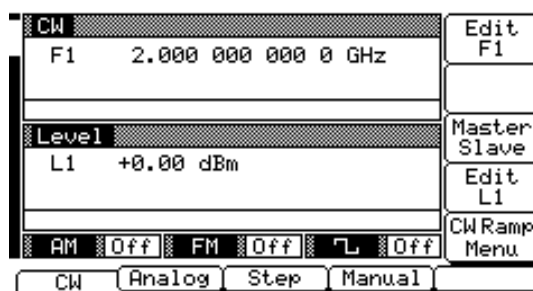

If you wish to follow along on your synthesizer, you can obtain this same menu display by resetting your instrument (press **SYSTEM**, then press **Reset**).

**Opening the
Parameter**

In order for the value of a parameter to be changed, the parameter must first be opened.

To open the frequency parameter from the above menu, press **Edit F1**. The menu display now changes to show that the menu soft-key **Edit F1** has been pressed and that the frequency parameter has been opened. An open parameter is indicated by placing it in a window with a movable cursor under its digits.

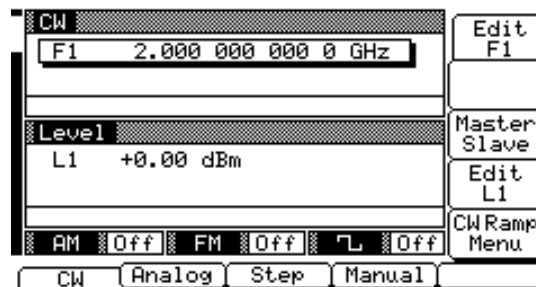

Only one parameter can be open at a time. If you press **Edit L1**, then the frequency parameter will close and the power level parameter will open.

Editing the Current Value

To change the current value of a parameter by editing, you can use either the cursor control key or the rotary data knob.

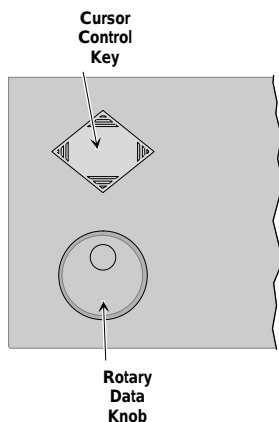

Using the Cursor Control Key

Using the < and > pads of the cursor control key, move the cursor under the digit where you want to begin editing. Then increase or decrease the value of the parameter using the ^ or v pad of the cursor control key. The unit size of the increase or decrease that occurs each time the ^ or v pad is pressed is determined by the cursor position.

Using the Rotary Data Knob

You can also increase or decrease the value of the parameter using the rotary data knob. Once you have positioned the cursor under the digit where you want to begin editing, slowly turn the knob clockwise or counter-clockwise to increase or decrease the value of the parameter by the unit size. Turning the knob rapidly changes the value of the parameter in larger steps.

Using a Set Increment

When editing frequency, power level, and time parameters, you can increase or decrease the parameter's value by a set amount each time the ^ or v pad is pressed or the rotary data knob is turned clockwise or counter-clockwise. For instructions on setting the increment size, refer to the System Configuration section of this chapter.

Now, try changing the current value of the CW frequency displayed on your synthesizer from 2.0 GHz to 6.395 GHz. Use both the cursor control key's ^ and v pads and the rotary data knob to make the value changes. When you are finished, your menu display should look like the example below.

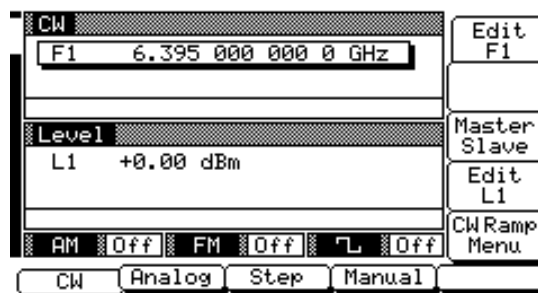

**Entering a
New Value**

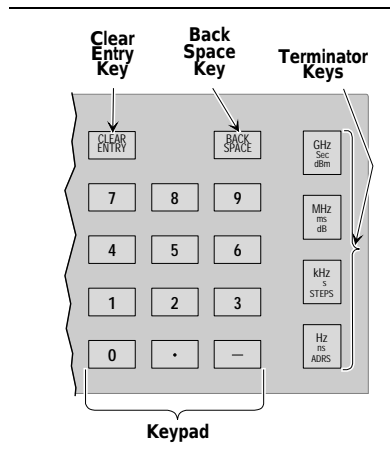

To close the open parameter when you are finished editing, press **Edit F1** or make another menu selection.

To change the current value of a parameter by entering a new value for the parameter, use the data entry keypad and termination keys.

As soon as you press one of the keys on the data entry keypad, the current parameter display clears for entry of a new value. Enter the new value for the parameter, then press the appropriate terminator key to store it in memory. If the entered value is outside the allowable range of the open parameter, the entry is not accepted and the previous value for the parameter is displayed.

NOTE

A frequency entry may be terminated in GHz, MHz, kHz, or Hz; however, it is always displayed on the data display in GHz. A time entry may be terminated in Sec, ms, μ s, or ns; however it is always displayed on the data display in Sec.

If you make an error during data entry, either (1) press **BACK SPACE** to delete the entry one character at a time starting from the last character entered, or (2) delete the entire entry by pressing **CLEAR ENTRY**. Then, reenter the correct value.

Now, try entering a new value for the CW frequency displayed on your synthesizer using the data entry keypad and termination keys.

To close the open parameter when you are finished entering data, press **Edit F1** or make another menu selection.

**3-7 CW FREQUENCY
OPERATION**

One of the sweep generator's major functions is to produce discrete CW frequencies across the frequency range of the instrument. The following paragraphs describe how to place the 681XXB in the CW frequency mode, select a CW frequency and power level for output, and activate the CW ramp. Use the CW Frequency Mode menu map (Chapter 4, Figure 4-2) to follow the menu sequences.

**Selecting
CW Mode**

To place the 681XXB in the CW frequency mode, press the main menu key



At the resulting menu display, press **CW**. The CW Menu (shown below) is displayed.

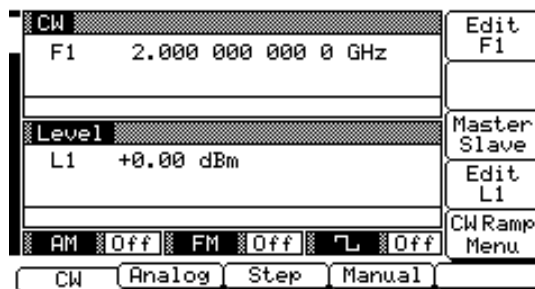

NOTE

Refer to Chapter 7, paragraph 7-2 for Master-Slave mode operating instructions.

NOTE

When the sweep generator is reset, it automatically comes up operating in the CW frequency mode.

**Selecting
a CW
Frequency**

There are several ways to select a CW frequency for output. You can (1) edit the current frequency, (2) enter a new frequency, or (3) select one of the 20 pre-set frequency parameters.

Editing the Current Frequency

Press **Edit F1** to open the frequency parameter, then edit the current CW frequency using the cursor control key or the rotary data knob. To close the open frequency parameter, press **Edit F1** or make another menu selection.

Entering a New Frequency

Press **Edit F1** to open the frequency parameter, then enter the new CW frequency using the keypad and appropriate terminator key. To close the open frequency parameter, press **Edit F1** or make another menu selection.

Selecting a Preset Frequency

To select one of the preset frequencies for output, press the main menu key

**FREQUENCY
CONTROL**

The CW Frequency Control menu, shown below, is displayed. This menu lets you (1) select preset frequencies F0, F1, F2, M1, or M2 for output, (2) go to the frequency list menu, or (3) go to the tagged frequencies menu.

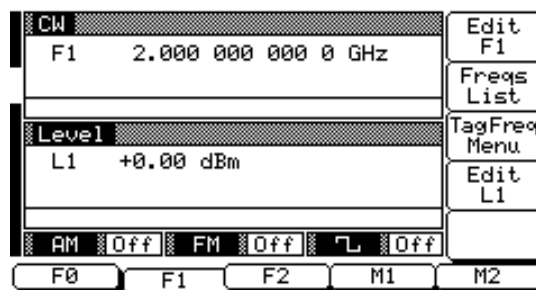

Frequency List—To go to the Frequency List menu (shown below), press **Freqs List**. This menu lets you tag, edit, or output a frequency from the list.

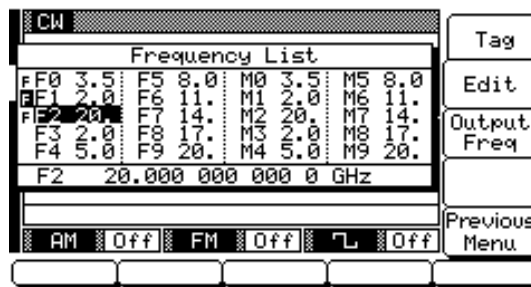

Use the cursor control key to select a frequency from the frequency list. The selected frequency is highlighted in reverse video and displayed in full below the frequency list.

Press **Tag** to mark a selected frequency (place an **F** in front of it). If the frequency is already tagged, pressing **Tag** will untag it (remove the **F**). Tagging selected frequencies lets you quickly switch between them using the scan keys of the Tagged Frequencies menu.

Press **Edit** to edit the selected frequency or enter a new frequency.

Press **Output Freq** to output the selected frequency. This frequency is output until you select another frequency from the list and press **Output Freq**. On the frequency list, the output frequency selection is marked by a black square or, if tagged, an **F** highlighted in reverse video.

When you are finished, press **Previous Menu** to return to the CW Frequency Control menu display.

Scanning Tagged Frequencies—To go to the Tagged Frequencies menu (shown below) from the CW Frequency Control menu, press **Tag Freq Menu**

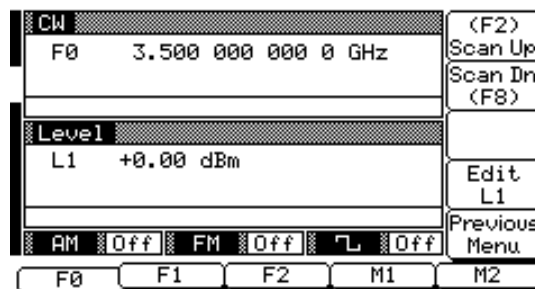

This menu lets you select the tagged frequencies for output using the **Scan Up** and **Scan Dn** keys.

Return to the CW Frequency Control menu by pressing **Previous Menu**.

**Selecting a
Power Level**

While in the CW frequency mode, you can edit the current CW frequency output power level or enter a new output power level.

Editing the Current Power Level

Press **Edit L1** to open the power level parameter, then edit the current power level using the cursor control key or rotary data knob. To close the open power level parameter, press **Edit L1** or make another menu selection.

Entering a New Power Level

Press **Edit L1** to open the power level parameter, then enter the new power level using the keypad and appropriate terminator key. To close the open power level parameter, press **Edit L1** or make another menu selection.

NOTE

You can also select any of the preset power levels or a power level sweep for a CW frequency. For instructions, refer to the Fixed Power Level Operation and Power Level Sweep Operation sections of this chapter.

CW Ramp

When active, the sweep generator's CW ramp provides a repetitive 0V to 10V ramp output to the rear panel HORIZ OUT BNC connector and AUX I/O connector. The CW ramp is used to drive a scalar analyzer display.

To go to the CW Ramp menu (shown below) from the CW menu, press **CW Ramp Menu**.



This menu lets you set the ramp speed and turn the CW ramp on/off.

To set ramp speed, press **Sweep Time**. The sweep time parameter opens for editing. Edit the current sweep time using the cursor control key or rotary data knob or enter a new sweep time using the key pad and appropriate termination key. The sweep time entered must be in the range of 30 ms to 99 sec. To close the open sweep time parameter when you are done, press **Sweep Time** or make another menu selection.

Press **CW Ramp** to turn the CW ramp on. While the CW ramp is on, the message **CW Ramp** appears on the right side of frequency title bar on all CW menus.

Press **Previous Menu** to return to the CW menu.

**3-8 SWEEP FREQUENCY
OPERATION**

The sweep generator can generate broad (full range) and narrow band sweeps across the frequency range of the instrument. The 681XXB has three sweep frequency modes—*analog sweep*, *step sweep*, and *manual sweep*. The following paragraphs describe how to select each sweep frequency mode, a sweep range, an output power level, a sweep trigger, and frequency markers. Use the Analog Sweep, Step Sweep, and Manual Sweep Frequency Mode menu maps (Chapter 4, Figures 4-3, 4-4, and 4-5) to follow the menu sequences.

**Selecting
Analog
Sweep Mode**

In analog sweep frequency mode, the sweep generator's output frequency is swept between selected start and stop frequencies. When the sweep width is >100 MHz, the sweep is phase-lock corrected at both the start and stop frequencies and at each band-switch point. When the sweep width is ≤100 MHz, only the center frequency of the sweep is phase-lock corrected.

To place the 681XXB in analog sweep frequency mode, press the main menu key

**CW/SWEEP
SELECT**

At the resulting menu display, press **Analog**. The Analog Sweep Menu (shown below) is then displayed.

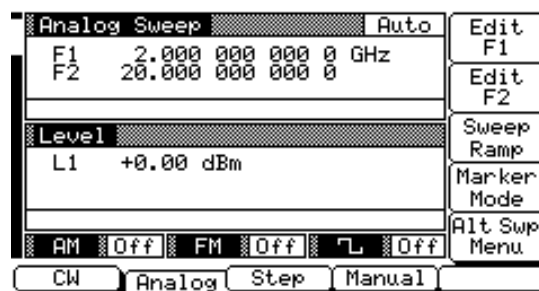

This menu lets you perform the following:

- Select a sweep range (edit the sweep start and stop frequency parameters).
- Go to the sweep ramp menu (set the sweep time and select a sweep trigger).
- Select a marker mode.
- Go to the alternate sweep menu.

**Setting the
Analog
Sweep Time**

The duration of the analog sweep can be set for any time in the range of 30 ms to 99 sec. The sweep time parameter is set from the sweep ramp menu.

To go to the Analog Sweep Ramp menu (shown below) from the Analog Sweep menu, press **Sweep Ramp**.

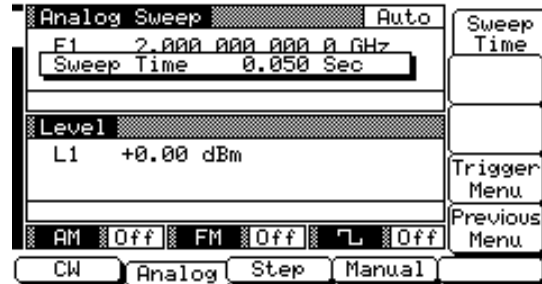

This menu lets you set the sweep time and go to the trigger menu.

To open the sweep time parameter for editing, press **Sweep Time**. Edit the current sweep time using the cursor control key or the rotary data knob or enter a new sweep time using the key pad and appropriate termination key. To close the open sweep time parameter once you have set the desired time, press **Sweep Time** or make another menu selection.

To go to the Analog Sweep Trigger menu from this menu, press **Trigger Menu**. Sweep trigger is described on the next page.

Press **Previous Menu** to return to the Analog Sweep menu.

**Selecting a
Sweep
Trigger**

The 681XXB provides sweep triggering for analog frequency sweep, step frequency sweep, and CW power sweep. The sweep generator has three modes of sweep triggering, each selectable from the trigger menu. The following is a description of each mode.

- ❑ **Auto (Automatic)**—The sweep continually sweeps from its start frequency or power level to its stop frequency or power level with optimal retrace time.
- ❑ **External**—The sweep recurs when triggered by an external TTL-compatible clock pulse to the rear panel AUX I/O connector.
- ❑ **Single**—A single sweep starts when the trigger key is pressed. If a sweep is in progress when the key is pressed, it aborts and resets.

To go to the Analog Sweep Trigger menu (shown below) from the Analog Sweep Ramp menu, press **Trigger Menu**.

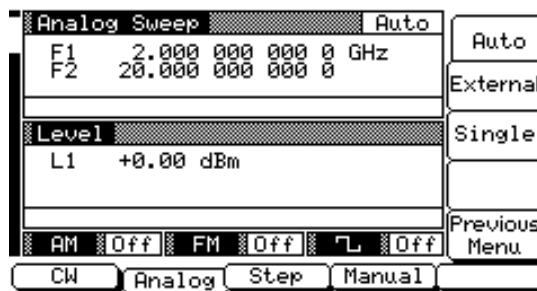

To select a sweep trigger mode, press its menu soft-key. A message showing the sweep trigger mode selected appears on the right side of frequency title bar. When you are finished, press **Previous Menu** to return to the Analog Sweep Ramp menu.

If you select the single sweep trigger mode, the menu display adds the menu soft-key **Trig**. Pressing **Trig** starts a single sweep. If a single sweep is in progress, pressing **Trig** causes the sweep to abort and reset.

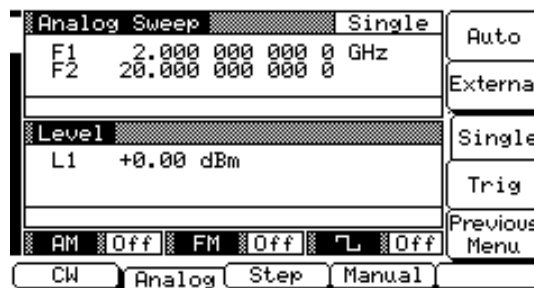

**Selecting
Step Sweep
Mode**

In step sweep frequency mode, the output frequency changes in discrete, synthesized steps between selected start and stop frequencies. Step sweeps can be from a high frequency to a low frequency and vice versa. The step size or number of steps between the start and stop frequencies and the dwell time-per-step are controllable from a step sweep menu.

To place the 681XXB in step sweep frequency mode, press the main menu key

**CW/SWEEP
SELECT**

At the resulting menu display, press **Step**. The Step Sweep Menu (shown below) is then displayed.

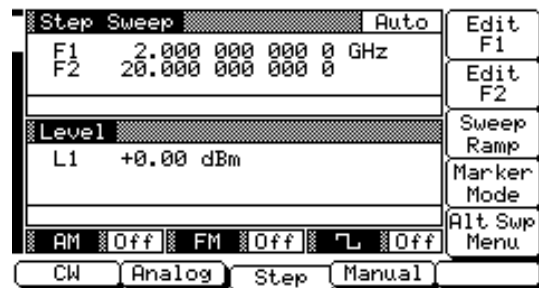

This menu lets you perform the following:

- Select a sweep range (edit the sweep start and stop frequency parameters).
- Go to the sweep ramp menu (set the dwell time-per-step, the step size or number of steps, and select a sweep trigger).
- Select a marker mode.
- Go to the alternate sweep menu.

**Setting Step
Size and
Dwell Time**

There are two ways to set the size of each step of the step sweep—set the step size or set the number of steps. The step size range is 1 kHz to the full frequency range of the sweep generator (0.1 Hz to full frequency range with Option 11); the number of steps range is 1 to 10,000. The dwell time-per-step of the step sweep can be set for any time in the range of 1 ms to 99 sec. The step size and dwell time-per-step parameters are set from the step sweep ramp menu.

To go to the Step Sweep Ramp menu (shown below) from the Step Sweep menu, press **Sweep Ramp**.

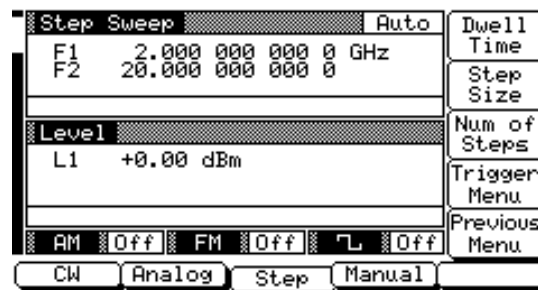

This menu lets you set the dwell time, the step size, the number of steps, and go to the trigger menu.

Press **Dwell Time** to open the dwell time-per-step parameter.

Press **Step Size** to open the step size parameter.

Press **Num of Steps** to open the number of steps parameter.

Open the parameter you wish to change, then edit the current value using the cursor control key or the rotary data knob or enter a new value using the key pad and appropriate termination key. When you have finished setting the open parameter, close it by pressing its menu soft-key or make another menu selection.

To go to the Step Sweep Trigger menu from this menu, press **Trigger Menu**. The trigger menu lets you select a sweep trigger (previously described on page 3-24).

Press **Previous Menu** to return to the Step Sweep menu.

RANGE

This error message is displayed when (1) the step size value entered is greater than the sweep range or (2) the number of steps entered results in a step size of less than 1 kHz (0.1 Hz with Option 11). Entering a valid step size will clear the error.

**Selecting
Manual
Sweep Mode**

In manual sweep frequency mode, the output frequency can be manually tuned in phase-locked steps between the selected start and stop frequencies using the rotary data knob. As the knob is turned, the current output frequency is displayed on the data display as Fm. The step size or number of steps between the start and stop frequencies are controllable from the manual sweep menu.

To place the 681XXB in manual sweep frequency mode, press the main menu key

**CW/SWEEP
SELECT**

At the resulting menu display, press **Manual**. The Manual Sweep menu (shown below) is then displayed.

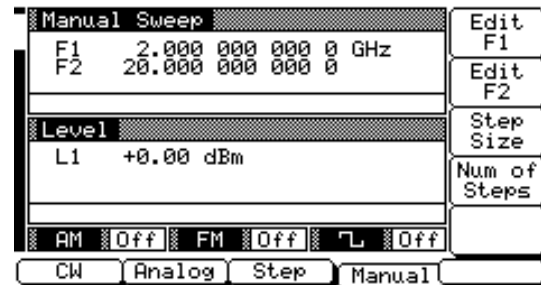

This menu lets you perform the following:

- Select a sweep range (edit the start and stop frequency parameters).
- Set the step size or number of steps (previously described on page 3-26).

**Selecting a
Sweep Range**

Selecting a sweep range involves choosing a start and a stop frequency for the frequency sweep. The sweep range selection process is identical for all sweep frequency modes (analog, step, and manual). There are several ways you can select a sweep range, including:

- Editing the current start and stop frequency parameter values.
- Entering new start and stop frequency parameter values.
- Selecting one of the preset sweep range parameters (F1-F2, F3-F4, F5-dF, or F6-dF).

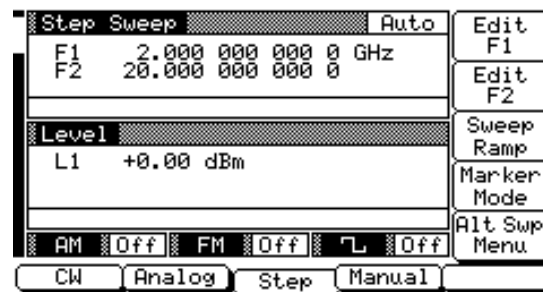

Editing the Current Start / Stop Frequencies

To edit the current sweep range start by opening either the start or stop frequency parameter (in the display above, **Edit F1** opens the start frequency parameter; **Edit F2** opens the stop frequency parameter).

Edit the open frequency parameter using the cursor control key or the rotary data knob. When you are finished, close the open parameter by pressing its menu edit soft-key or by making another menu selection.

Entering New Start / Stop Frequencies

To enter a new sweep range start by opening either the start or stop frequency parameter (press **Edit F1** or **Edit F2**).

Enter a new frequency using the keypad and appropriate terminator key. When you are finished, close the open parameter by pressing its menu edit soft-key or by making another menu selection.

RANGE

This error message is displayed when (1) the analog sweep start frequency entered is greater than the stop frequency, or (2) the dF value entered results in a sweep outside the range of the 681XXB. Entering valid values will clear the error.

Selecting a Preset Sweep Range

There are four preset sweep range parameters, selectable in the analog sweep, step sweep, and manual sweep frequency modes. The following is a description of each preset sweep range.

- **F1-F2**—provides a frequency sweep between the start frequency, F1, and the stop frequency, F2.
- **F3-F4**—provides a frequency sweep between the start frequency, F3, and the stop frequency, F4.
- **F5-dF**—provides a symmetrical frequency sweep about the center frequency, F5. The sweep width is determined by the dF frequency parameter.
- **F6-dF**—provides a symmetrical frequency sweep about the center frequency, F6. The sweep width is determined by the dF frequency parameter.

To select one of the preset sweep ranges from any sweep frequency mode menu, press the main menu key

**FREQUENCY
CONTROL**

The Sweep Frequency Control menu, shown below, is displayed.

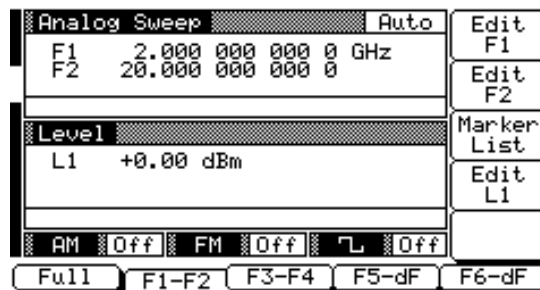

This menu lets you perform the following:

- Select a full range sweep (Fmin–Fmax) or one of the preset sweep ranges for the sweep frequency mode.
- Select the frequency parameters for each preset sweep range.
- Select an output power level for the sweep.
- Go to the marker list menu.

Setting a Preset Sweep Range—At the menu, select the sweep range (F1-F2, F3-F4, F5-dF, or F6-dF) that you wish to set. The menu then displays the current frequency parameters for the selected sweep range. Now, use the menu edit soft-keys to open the frequency parameters for editing.

Edit the current frequency parameters or enter new frequency parameter values for the sweep range. To close the open frequency parameter when you are finished, press its menu edit soft-key or make another menu selection.

You can set all the preset sweep ranges in this manner.

Selecting a Power Level

While at the Sweep Frequency Control menu, you can edit the current output power level or enter a new output power level for the frequency sweep.

Editing the Current Power Level

Press **Edit L1** to open the power level parameter, then edit the current power level using the cursor control key or rotary data knob. To close the open power level parameter, press **Edit L1** or make another menu selection.

Entering a New Power Level

Press **Edit L1** to open the power level parameter, then enter the new power level using the keypad and appropriate terminator key. To close the open power level parameter, press **Edit L1** or make another menu selection.

NOTE

You can also select any of the preset power levels for a frequency sweep or a power level step for analog and step sweeps. For instructions, refer to the Fixed Power Level Operation and Power Level Sweep Operation sections of this chapter.

**Frequency
Markers**

The sweep generator provides up to 20 independent, pre-settable markers, F0-F9 and M0-M9, that can be used in the analog and step sweep frequency modes for precise frequency identification. Marker frequency accuracy is the same as sweep frequency accuracy. The markers are visible on a CRT display.

The 681XXB generates two types of markers.

- **Video Marker**—produces a pulse on a CRT display at each marker frequency. The video marker is either a +5V or a -5V pulse at the rear panel. The polarity of the video marker pulse is selectable from a system configuration menu.
- **Intensity Marker**—produces an intensified dot on a CRT display at each marker frequency. Intensity markers are only available in the analog sweep frequency mode and are obtained from a momentary dwell during the sweep at each marker frequency.

To output markers during a sweep you must first select (tag) the marker frequencies from the Marker List menu, then turn on the marker output.

To go to the Marker List menu from an analog or step sweep frequency menu, press

**FREQUENCY
CONTROL**

The Sweep Frequency Control menu, shown below, is displayed.

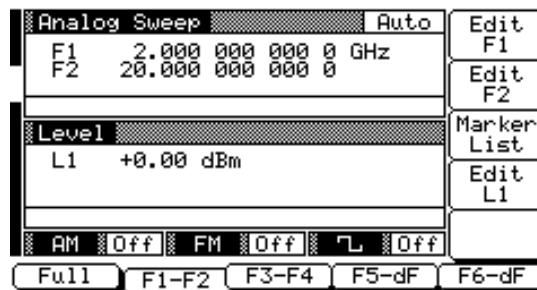

To go to the Marker List menu from this menu, press **Marker List**. The Marker List menu, shown on the next page, is displayed. This menu lets you tag or edit marker list frequencies and turn the markers on/off.

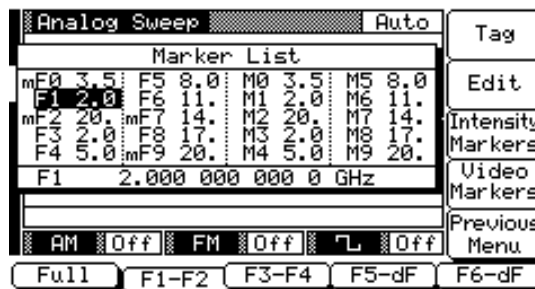

Use the cursor control key to select a frequency parameter from the marker list. The selected frequency parameter is highlighted in reverse video and displayed in full below the marker list.

Editing a Marker List Frequency

If you want to change a selected marker list frequency parameter's value, press **Edit** to open the frequency parameter, then edit the current frequency or enter a new frequency.

Tagging a Marker List Frequency

Only frequencies on the marker list that have been tagged can be output as markers during a sweep. Press **Tag** to tag a selected frequency parameter (place an **m** in front of it). If a frequency parameter is already tagged, pressing **Tag** will untag it (remove the **m**).

Activating Markers

The soft-keys **Video Markers** and **Intensity Markers** toggle the markers on and off.

Video Markers—To output the tagged marker frequencies as video markers during an analog or step sweep, press **Video Markers**. Video markers will be displayed on the CRT for all tagged marker frequencies that are within the sweep frequency range.

Intensity Markers—(only available in analog sweep frequency mode) To output the tagged marker frequencies as intensity markers during an analog sweep, press **Intensity Markers**. Intensity markers will be displayed on the CRT for all tagged marker frequencies that are within the analog sweep frequency range.

Press **Previous Menu** to return to the Sweep Frequency Control menu.

**Selecting
Alternate
Sweep Mode**

In alternate sweep frequency mode, the sweep generator's output frequency sweeps alternately between any two sweep ranges in analog sweep or any two sweep ranges in step sweep. The process of selecting and activating the alternate sweep is identical for both analog and step sweep frequency modes.

To select the alternate sweep mode for analog sweeps, start with the Analog Sweep Menu display; to select the alternate sweep mode for step sweeps, start with the Step Sweep Menu display (shown below).

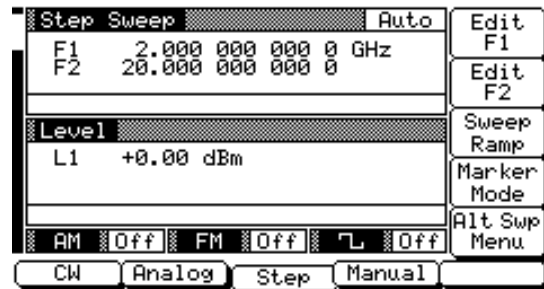

To go to the Alternate Sweep menu (shown below) from the Step Sweep menu, press **Alt Swp Menu**.

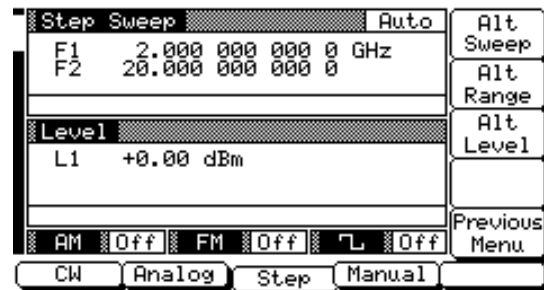

This menu lets you perform the following:

- Turn the alternate sweep mode on/off.
- Go to the alternate range menu to select a sweep range for the alternate sweep.
- Go to the alternate level menu to select a power level for the alternate sweep.

Activating the Alternate Sweep

The Alternate Sweep menu soft-key **Alt Sweep** toggles the alternate sweep mode on and off.

Press **Alt Sweep** to turn on the alternate sweep mode. Notice that the Alternate Sweep menu (shown below) changes to show that the alternate sweep is now active.

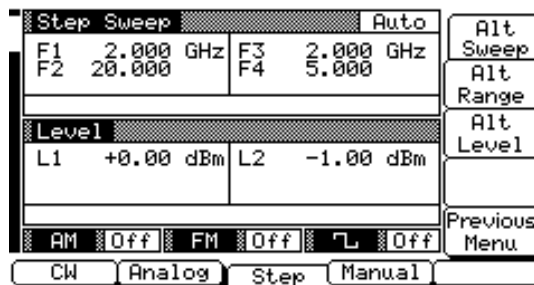

Now, press **Previous Menu** to return to the Step Sweep Menu display (or the Analog Sweep Menu display if operating in analog sweep frequency mode).

Notice the changes to the Step Sweep Menu display (shown below). These changes indicate that the alternate sweep frequency mode is active.

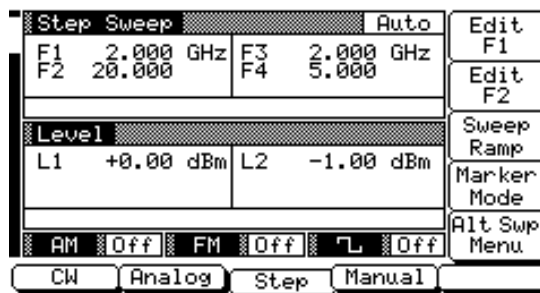

Now, press **Alt Swp Menu** to return to the Alternate Sweep menu.

Selecting an Alternate Sweep Range

To go to the Alternate Range menu (shown below) from the Alternate Sweep menu, press **Alt Range**.

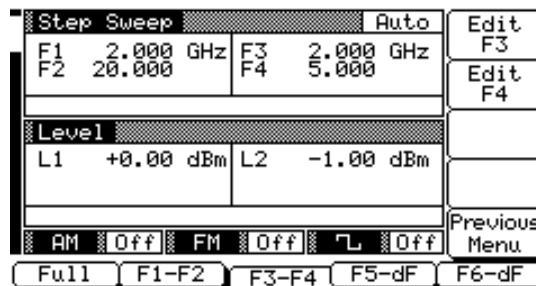

Select the alternate sweep range (Full, F1-F2, F3-F4, F5-dF, or F6-dF). The menu then displays the current frequency parameters for the selected sweep range. If you wish to change a frequency parameter, use the menu edit soft-key to open the parameter, then edit it.

When you are done selecting the alternate sweep range, press **Previous Menu** to return to the Alternate Sweep menu.

Selecting an Alternate Sweep Power Level

To go to the Alternate Level menu (shown below) from the Alternate Sweep menu, press **Alt Level**.

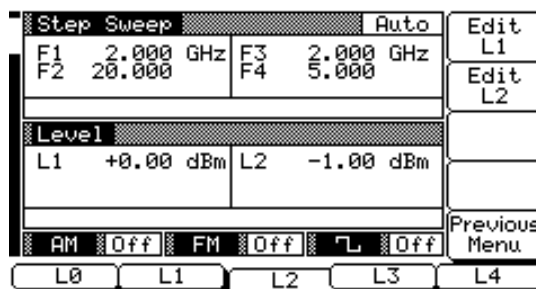

Select the power level for the alternate sweep range (L0, L1, L2, L3, or L4). The menu then displays the current level parameter for the selected power level. If you wish to change the level, use the menu edit soft-key to open the parameter, then edit it.

A menu edit soft-key is also provided to let you change the power level of the main sweep.

When you are done selecting the power level for the alternate sweep range and editing the power level of the main sweep, press **Previous Menu** to return to the Alternate Sweep menu.

CAUTION
Performing alternate sweeps using power levels that cross step attenuator switch points can cause excessive wear on the switches and reduce the life expectancy of the step attenuator.

**3-9 FIXED POWER LEVEL
OPERATION**

The sweep generator provides leveled output power over a maximum range of up to 28 dB (up to 136 dB with Option 2) for CW and sweep frequency operations. Instruments with Option 15 provide leveled output power over a maximum range of up to 22 dB (up to 130 dB with Option 2). The following paragraphs describe how to place the 681XXB in fixed (non-swept) power level mode, select a power level for output, and activate level offset. Use the Fixed (Non-Swept) Power Level Mode menu map (Chapter 4, Figure 4-6) to follow the menu sequences.

**Selecting
Fixed Power
Level Mode**

To place the 681XXB in a fixed power level mode from a CW or sweep (analog, step, or manual) frequency menu, press the main menu key

**LEVEL/ALC
SELECT**

At the resulting menu display, press **Level**. The Level Menu (shown below) is displayed.

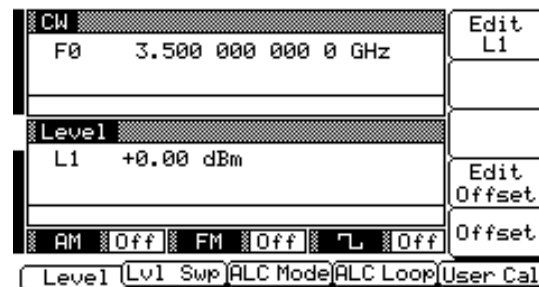

This menu lets you perform the following:

- Edit the power level parameter.
- Edit the level offset parameter.
- Turn level offset on/off.

**Selecting a
Power Level**

There are several ways to select a power level for output. You can (1) edit the current power level, (2) enter a new power level, or (3) select one of the 10 preset power level parameters.

Editing the Current Power Level

Press **Edit L1** to open the power level parameter, then edit the current power level using the cursor control key or the rotary data knob. To close the open power level parameter, press **Edit L1** or make another menu selection.

Entering a New Power Level

Press **Edit L1** to open the power level parameter, then enter the new power level using the keypad

and appropriate terminator key. To close the open power level parameter, press **Edit L1** or make another menu selection.

Selecting a Preset Power Level

To select one of the preset power levels for output, press the main menu key

**LEVEL
CONTROL**

The Level Control menu, shown below, is displayed.

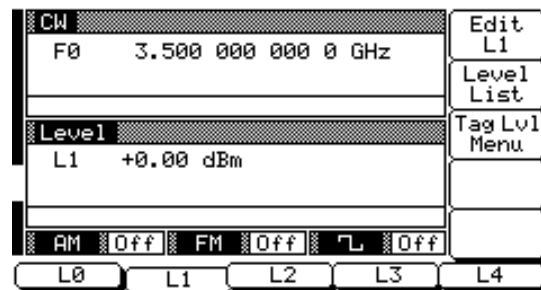

This menu lets you perform the following:

- Select preset power levels L0, L1, L2, L3, or L4 for output.
- Go to the Level List menu.
- Go to the Tagged Levels menu.

Level List– To go to the Level List menu (shown below), press **Level List**.

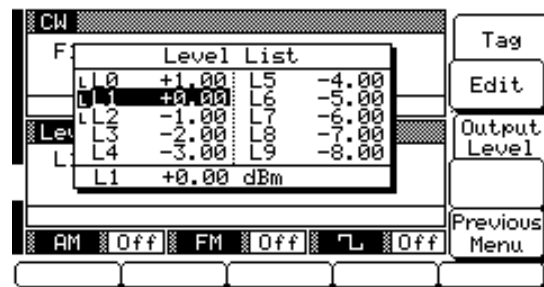

This menu lets you select a power level from the list to tag, edit, or output.

Use the cursor control key to select a power level from the level list. The selected power level is highlighted in reverse video and displayed in full below the level list.

Press **Tag** to mark a selected power level (place an L in front of it). If a power level is already tagged, pressing **Tag** will untag it (remove the L). Tagging selected power levels lets you quickly switch between them using the scan keys of the Tagged Levels menu.

Press **Edit** to edit the selected power level or enter a new power level.

Press **Output Level** to output the selected level. This power level is output until you select another level from the list and press **Output Level**. On the level list, the output power level selection is marked by a black square or, if tagged, an L highlighted in reverse video.

When you are finished, press **Previous Menu** to return to the Level Control menu display.

Scanning Tagged Levels—To go to the Tagged Levels menu (shown below) from the Level Control menu, press **Tag Lvl Menu**.

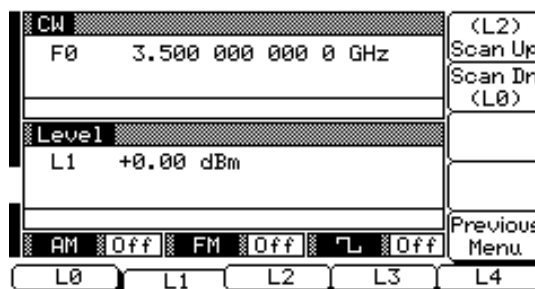

This menu lets you select the tagged power levels for output using the **Scan Up** and **Scan Dn** keys.

Return to the Level Control menu display by pressing **Previous Menu**.

Level Offset

Level offset lets you compensate for a device on the sweep generator's output that alters the RF output power level at the point of interest. For example, the power level at the test device may be less or more than the displayed power level because of the loss through an external transmission line or the gain of an amplifier located between the 681XXB RF output and the test device. Using the level offset function, you can apply a constant to the displayed power level that compensates for this loss or gain. The displayed power level will then reflect the actual power level at the test device.

To enter an offset value and apply it to the displayed power level, go to the Level Menu. Then press **Edit Offset**. As shown in the following menu, this opens the offset parameter for editing.

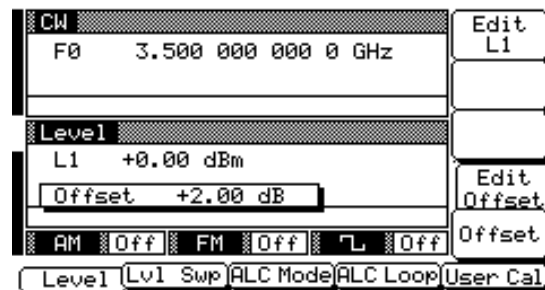

Edit the current offset value using the cursor control key or rotary data knob or enter a new offset value using the keypad and appropriate terminator key. To close the open offset parameter when you are done, press **Edit Offset** or make another menu selection.

Press **Offset** to apply the offset to the displayed power level. In this example, a +2.00 dB offset is applied to L1. L1 then displays a power level of +2.00 dBm.

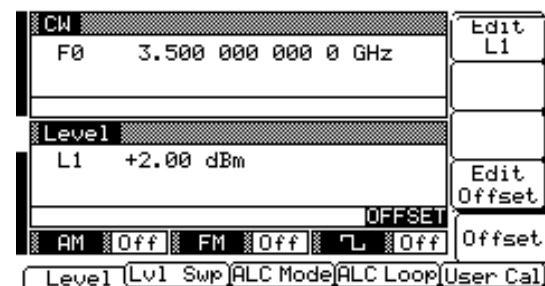

OFFSET

When Offset is selected ON, this status message is displayed on all menu displays to remind the operator that a constant (offset) has been applied to the displayed power level.

**3-10 POWER LEVEL
SWEEP OPERATION**

The sweep generator provides leveled output power sweeps at CW frequencies and in conjunction with frequency sweeps (analog and step). Power level sweeps can be from a high level to a low level or vice versa. The following paragraphs provide descriptions and operating instructions for the CW power sweep mode and the sweep frequency/step power modes. Use the CW Power Sweep Mode and Sweep Frequency/Step Power Mode menu maps (Chapter 4, Figures 4-7 and 4-8) to follow the menu sequences.

**Selecting
CW Power
Sweep Mode**

In the CW power sweep mode, output power steps between any two power levels at a single CW frequency. Menus provided let you set or select the sweep range, the step size, the dwell time-per-step, and the sweep trigger.

CAUTION

Performing power level sweeps that cross step attenuator switch points can cause excessive wear on the switches and reduce the life expectancy of the step attenuator.

To place the 681XXB in a CW power sweep mode from a CW frequency menu, press the main menu key

**LEVEL/ALC
SELECT**

At the resulting menu display, press **Lvl Swp**. The CW Level Sweep Menu (shown below) is displayed.

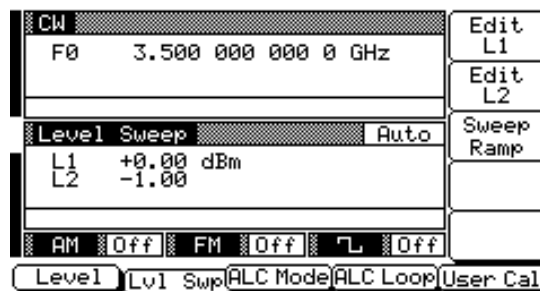

This menu lets you perform the following:

- Select a power level sweep range (edit the sweep start and stop power level parameters).
- Go to the sweep ramp menu (set the dwell time-per-step, the step size or number of steps, and select a sweep trigger).

**Setting CW
Power Sweep
Step Size
and Dwell
Time**

There are two ways to set the size of each step of the CW power sweep—set the step size or set the number of steps. The step size range is 0.01 dB to the full power range of the synthesizer; the number of steps range is 1 to 10,000. The dwell time-per-step of the CW power sweep can be set for any time in the range of 1 ms to 99 sec. The step size and dwell time-per-step are set from the CW level sweep ramp menu.

To go to the CW Level Sweep Ramp menu from the CW Level Sweep menu, press **Sweep Ramp**.

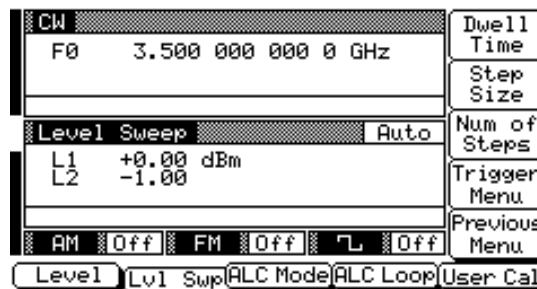

This menu lets you set the dwell time, the step size, the number of steps, and go to the trigger menu.

Press **Dwell Time** to open the dwell time-per-step parameter.

Press **Step Size** to open the step size parameter.

Press **Num of Steps** to open the number of steps parameter.

Open the parameter you wish to change, then edit the current value using the cursor control key or rotary data knob or enter a new value using the key pad and appropriate termination key. When you have finished setting the open parameter, close it by pressing its menu soft-key or by making another menu selection.

To go to the CW Level Sweep Trigger menu from this menu, press **Trigger Menu**. The trigger menu lets you select a CW power sweep trigger (described on page 3-42).

Press **Previous Menu** to return to the CW Level Sweep menu.

RANGE

This error message is displayed when (1) the step size value entered is greater than the level sweep range or (2) the number of steps entered results in a step size of less than 0.01 dB. Entering a valid step size will clear the error.

**Selecting a
CW Power
Sweep
Trigger**

There are three modes of triggering provided for the CW power sweep—automatic, external, and single. The sweep trigger is selectable from the CW Level Sweep Trigger menu. The following is a description of each trigger mode.

- ❑ **Auto (Automatic)**—The CW power sweep continually sweeps from its start power level to its stop power level with optimal retrace time.
- ❑ **External**—The CW power sweep recurs when triggered by an external TTL-compatible clock pulse to the rear panel AUX I/O connector.
- ❑ **Single**—A single CW power sweep starts when the trigger key is pressed. If a sweep is in progress when the key is pressed, it aborts and re-sets.

To go to the CW Level Sweep Trigger menu (shown below) from the CW Level Sweep Ramp menu, press **Trigger Menu**.

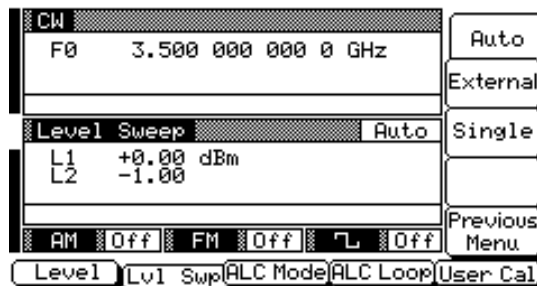

To select a CW power sweep trigger mode, press its menu soft-key. A message showing the CW power sweep trigger mode selected appears on the right side of the level mode title bar.

If you select the single sweep trigger mode, the menu display changes, adding the menu soft-key labeled **Trig**. Pressing **Trig** starts a single CW power sweep. If a single CW power sweep is in progress, pressing **Trig** causes the sweep to abort and reset.

Press **Previous Menu** to return to the CW Level Sweep Ramp menu.

**Selecting a
Power Level
Sweep Range**

Selecting a power level sweep range consists of choosing a start and stop level for the power level sweep. The power level sweep range selection process is identical for all power level sweep modes—CW power sweep, analog sweep frequency/step power, and step sweep frequency/step power. You can select a power level sweep range as follows:

- Edit the current start and stop power level parameter values.
- Enter new start and stop power level parameter values.
- Select one of the preset power level sweep range parameters (L1-L2, L3-L4, L5-L6, L7-L8, or L9-L0).

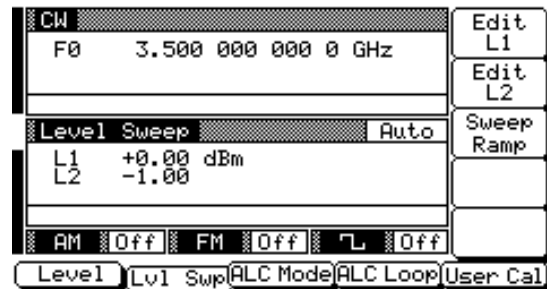

Editing the Current Start / Stop Power Levels

To edit the current power level sweep range, start by opening either the start or stop power level parameter (in the display above, **Edit L1** opens the start power level parameter; **Edit L2** opens the stop power level parameter).

Edit the open power level parameter using the cursor control key or the rotary data knob. When you are finished, close the open parameter by pressing its menu edit soft-key or by making another menu selection.

Entering New Start / Stop Power Levels

To enter a new power level sweep range start by opening either the start or stop power level parameters (press **Edit L1** or **Edit L2**).

Enter a new power level using the keypad and appropriate terminator key. When you are finished, close the open parameter by pressing its menu edit soft-key or by making another menu selection.

Selecting a Preset Power Level Sweep Range

There are five preset power level sweep range parameters selectable in the power level sweep modes. These preset power level sweep range parameters are L1-L2, L3-L4, L5-L6, L7-L8, and L9-L0.

To select one of the preset power level sweep ranges from a Level Sweep menu, press the main menu key

**LEVEL
CONTROL**

The Level Sweep Control menu, shown below, is displayed.

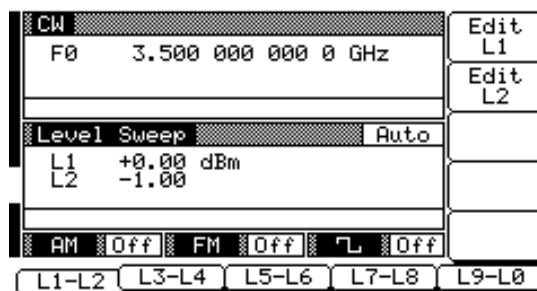

In addition to letting you select one of the preset sweep ranges for the power level sweep, this menu lets you set the start and stop power level parameters for each preset sweep range.

Setting a Preset Power Level Sweep Range—At the Level Sweep Control menu, select the power level sweep range (L1-L2, L3-L4, L5-L6, L7-L8, or L9-L0) that you wish to set. The menu then displays the current power level parameters for the selected power level sweep range. Now, use the menu edit soft-keys to open the power level parameters for editing.

Edit the current power level parameter values or enter new power level parameter values for the power level sweep range. To close the open power level parameter when you are finished, press its menu edit soft-key or make another menu selection.

You can set all the preset power level sweep ranges in this manner.

**Selecting a
Sweep Fre-
quency / Step
Power Mode**

In analog sweep frequency/step power mode or step sweep frequency/step power mode, a power level step occurs after each frequency sweep. The power level remains constant for the length of time required to complete each frequency sweep. Menus provided let you control the power level sweep range and step size.

To select an analog sweep frequency/step power mode, start with an analog sweep menu display; to select a step sweep frequency/step power mode, start with a step sweep menu display. Then press the main menu key

**LEVEL/ALC
SELECT**

At the resulting menu display, press **Lvl Swp**. The Level Sweep Menu is displayed.

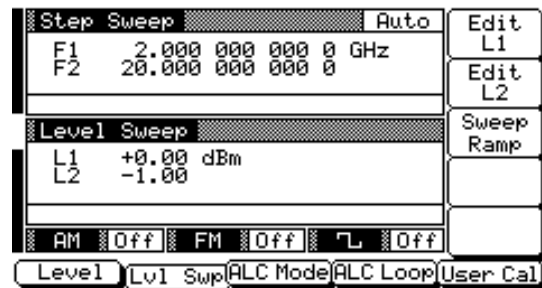

This menu lets you perform the following:

- Select a power level sweep range (edit the sweep start and stop power level parameters).
- Go to the sweep ramp menu (set the step size or number of steps).

**Setting
Power Level
Step Size**

There are two ways to set the step size of the power level step that occurs after each frequency sweep—set the step size or set the number of steps. The step size range is 0.01 dB to the full power range of the synthesizer; the number of steps range is 1 to 10,000. The power level step size is set from the level sweep ramp menu.

To go to the Level Sweep Ramp menu from the Level Sweep menu, press **Sweep Ramp**.

| | | | |
|-------------|------------------|----------|---------------|
| Step Sweep | | Auto | Dwell Time |
| F1 | 2.000 000 000 0 | GHz | Step Size |
| F2 | 20.000 000 000 0 | | Num of Steps |
| Level Sweep | | | Trigger Menu |
| L1 | +0.00 dBm | | Previous Menu |
| L2 | -1.00 | | |
| AM | Off | FM | Off |
| | | ⌂ | Off |
| Level | Lvl Swp | ALC Mode | ALC Loop |
| | | User Cal | |

This menu lets you set the step size and the number of steps.

Press **Step Size** to open the step size parameter.

Press **Num of Steps** to open the number of steps parameter.

Open the parameter you wish to change, then edit the current value using the cursor control key or rotary data knob or enter a new value using the keypad and appropriate termination key. When you have finished setting the open parameter, close it by pressing its menu soft-key or by making another menu selection.

Press **Previous Menu** to return to the Level Sweep menu.

RANGE

This error message is displayed when (1) the step size value entered is greater than the level sweep range or (2) the number of steps entered results in a step size of less than 0.01 dB. Entering a valid step size will clear the error.

**3-11 LEVELING
OPERATIONS**

The 681XXB generates leveled output power over a maximum range of up to 28 dB (up to 136 dB with Option 2). Instruments with Option 15 provide leveled output power over a maximum range of up to 22 dB (up to 130 dB with Option 2). An automatic level control (ALC) system controls the amplitude and power level of the RF output. The operator can select the ALC mode of operation—internal, external (detector or power meter), or fixed gain (ALC off). In addition, the 681XXB provides (1) an ALC power slope function that provides compensation for high frequency system or cable losses, (2) a decouple function that allows decoupling of the step attenuator (if equipped) from the ALC system, and (3) a user level (flatness correction) calibration function that provides for calibrating out path variations with frequency in a test setup.

The following paragraphs provide descriptions and operating instructions for the power leveling modes and functions. Use the Leveling Modes menu map (Chapter 4, Figure 4-9) to follow the menu sequences.

**Selecting a
Leveling
Mode**

The ALC system is a feedback control system, in which the output power is measured at a detector and compared with the expected power level. If the output and desired power levels do not equal, the ALC adjusts the power output until they equal. The feedback signal can be provided by either the internal detector or an external detector or power meter. Alternately, the output power can be set to a fixed level without using the normal feedback (ALC off). The ALC mode menu lets you make the selection of a leveling mode.

To go to the ALC Mode menu, first press the main menu key

**LEVEL/ALC
CONTROL**

At the Level/ALC Control Menu display, press **ALC Mode**. The ALC Mode Menu (shown below) is displayed.

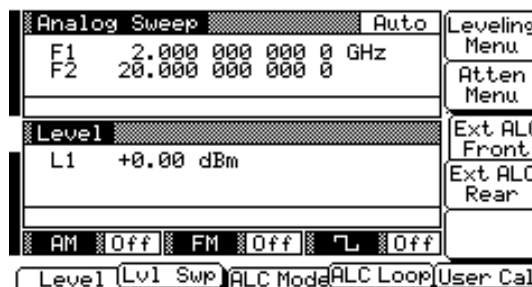

The ALC Mode menu lets you perform the following:

- Go to the leveling menu (select the ALC mode of operation).
- Go to the attenuation menu (decouple the attenuator, if equipped, from the ALC system and set the power level and attenuation).
- Select either the front panel or rear panel external ALC input.

Internal Leveling

This is the normal (default) leveling mode. Output power is sensed by the internal detector in the 681XXB. The detector output signal is fed back to the ALC circuitry to adjust the output power level. Internal ALC is selected from the leveling menu.

To go to the Leveling Menu from the ALC Mode menu, press **Leveling Menu**. The Leveling Menu, shown below, is displayed.

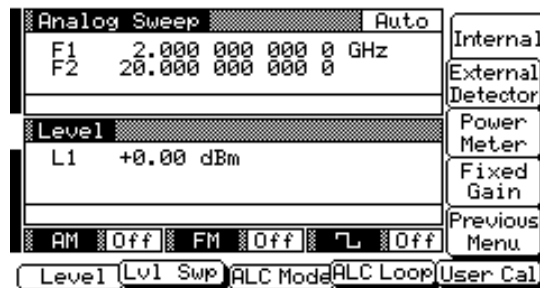

To select internal ALC, press **Internal**.

Pressing one of the other leveling menu soft-keys **External Detector**, **Power Meter**, or **Fixed Gain** will turn off internal leveling.

Press **Previous Menu** to return to the ALC Mode menu.

External Leveling

In external leveling, the output power from the 681XXB is detected by an external detector or power meter. The signal from the detector or power meter is returned to the ALC circuitry. The ALC adjusts the output power to keep the power level constant at the point of detection. The external ALC source input is selected from the leveling menu.

Before going to the Leveling Menu from the ALC Mode menu, select which input (front- or rear-panel) the external ALC signal is connected to.

At the ALC Mode menu, press **Ext ALC Front** to select front panel input, or **Ext ALC Rear** to select rear panel input.

Now, press **Leveling Menu** to go to the Leveling Menu.

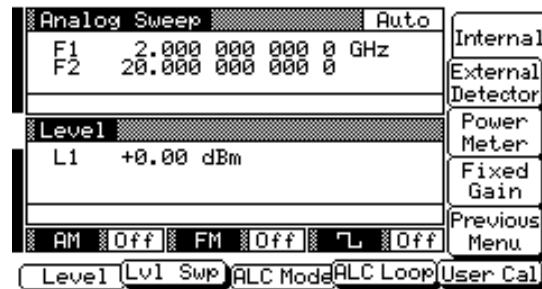

Next, select the type of external sensor you are using to detect the output power.

To select the external ALC input from an external detector, press **External Detector**.

To select the external ALC input from a power meter, press **Power Meter**.

After you have made the external ALC input connection and selected the sensor type, press **ALC Loop**. The ALC Loop Menu (shown below) is displayed.

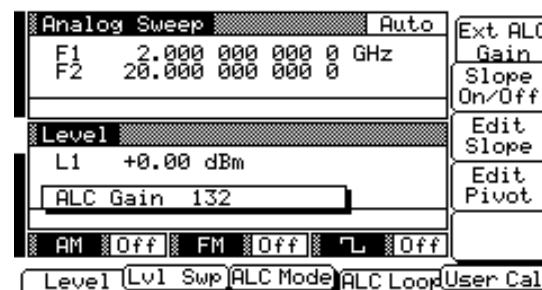

Press **Ext ALC Gain** to set the external ALC Gain.

While monitoring the power level at the external detection point, use the cursor control key or rotary data knob to adjust the ALC gain for stable ALC loop operation.

To return to the Leveling Menu, press **ALC Mode** then press **Leveling Menu**.

At the Leveling menu, pressing either **Internal** or **Fixed Gain** will turn off external leveling.

Press **Previous Menu** to return to the ALC Mode menu.

Fixed Gain

In the fixed gain mode, the ALC is disabled. The RF Level DAC and step attenuator (if installed) are used to control the relative power level. Power is not detected at any point, and the absolute power level is uncalibrated. Fixed gain mode is selected from the leveling menu.

Press **Leveling Menu** to go to the Leveling menu.

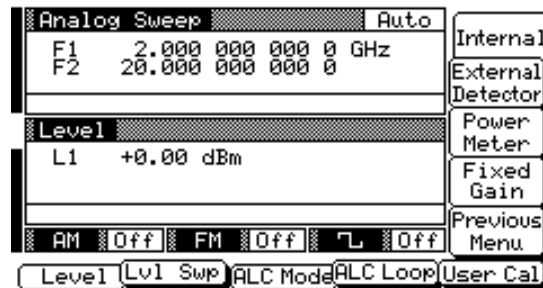

To select fixed gain mode, press **Fixed Gain** .

To return to normal ALC operation, press **Internal** .

Press **Previous Menu** to return to the ALC Mode menu.

**Attenuator
Decoupling**

In 681XXBs equipped with option 2 step attenuators, the ALC and attenuator work in conjunction to provide leveled output power down to -125 dBm. In the normal (coupled) leveling mode, when the desired power level is set, the correct combination of ALC level and attenuator setting is determined by the instrument firmware. In some applications, such as receiver sensitivity testing, it is desirable to control the ALC level and attenuator setting separately by decoupling the step attenuator from the ALC. The ALC mode menu lets you select attenuator decoupling.

At the ALC Mode menu, press **Atten Menu**. The Attenuator Menu (shown below) is displayed.

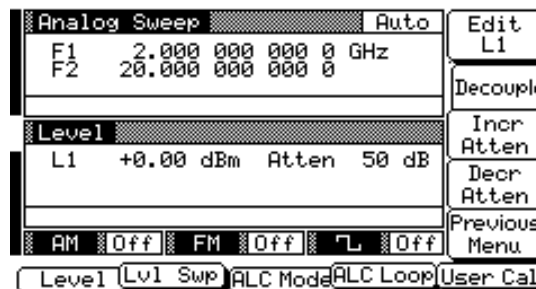

This menu lets you decouple the step attenuator from the ALC, set the power level, and set the attenuation in 10 dB steps.

Press **Decouple** to decouple the step attenuator from the ALC.

Press **Edit L1** to open the power level parameter for editing. Edit the current level using the cursor control key or rotary data knob or enter a new value using the key pad and appropriate termination key. When you have finished setting the power level, press **Edit L1** to close the open parameter.

To change the attenuation setting, press **Incr Atten** or **Decr Attn**. Pressing these soft-keys changes the attenuation in 10 dB steps.

Press **Previous Menu** to return to the ALC Mode menu.

NOTE
The set power level may not be maintained when switching between attenuator coupling modes.

**ALC Power
Slope**

The ALC power slope function lets you compensate for system, cable, and waveguide variations due to changes in frequency, by linearly increasing or decreasing power output as the frequency increases. As shown in the following illustration, the power slope function provides you with the ability to set both the power slope and the pivot point. The ALC loop menu lets you activate the ALC power slope function.

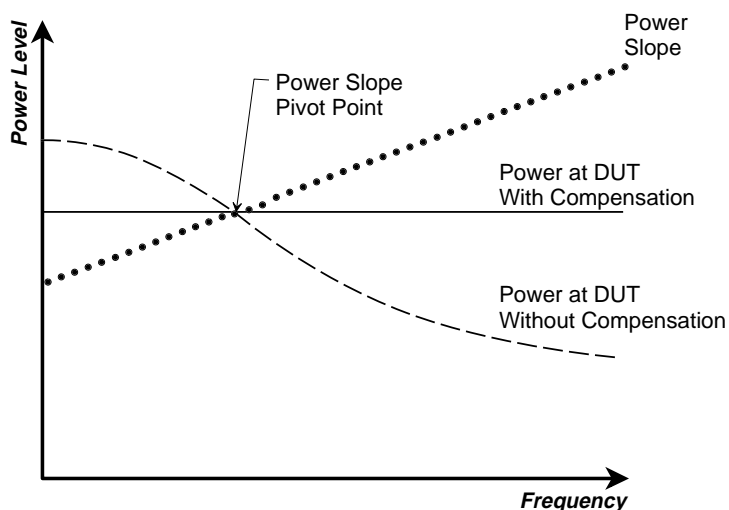

To go to the ALC Loop Menu from the Level/ALC Control Menu display, press **ALC Loop**. The ALC Loop Menu (shown below) is displayed.

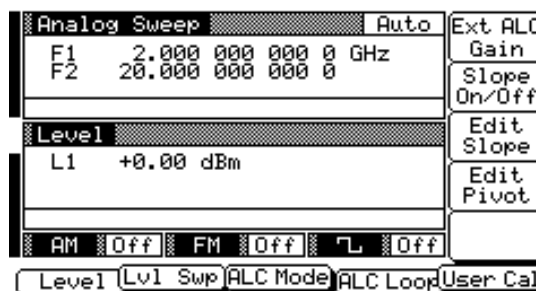

This menu lets you turn the power slope on or off and edit the slope value and pivot point frequency.

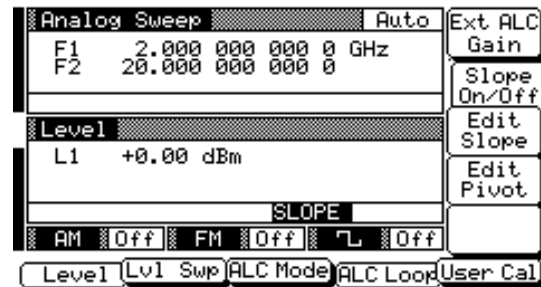

Press **Slope On/Off** to activate the ALC power slope function.

Press **Edit Pivot** to open the pivot point frequency parameter for editing. Edit the current frequency using the cursor control key or rotary data knob or enter a new value using the keypad and appropriate termination key. When you have finished setting the open parameter, close it by pressing **Edit Pivot** again or by making another menu selection.

Press **Edit Slope** to open the slope parameter for editing. Edit the current slope value using the cursor control key or rotary data knob or enter a new value using the key pad and the STEPS termination key. When you have finished setting the open parameter, close it by pressing **Edit Slope** again or by making another menu selection.

While monitoring the power level at the device-under-test (DUT), adjust the power slope and pivot point to level the power at the DUT.

SLOPE

When Power Slope is selected ON, this status message is displayed on all menu displays to remind the operator that a power slope correction has been applied to the ALC.

***User Cal
(User Level
Flatness
Correction)***

The User Cal (user level flatness correction) function lets you calibrate out path variations with frequency that are caused by external switching, amplifiers, couplers, and cables in the test setup. This is done by means of an entered power-offset table from a GPIB power meter or calculated data. When user level flatness correction is activated, the set power level is delivered at the point in the test setup where the calibration was performed. This “flattening” of the test point power level is accomplished by summing a power-offset word (from the power-offset table) with the sweep generator’s normal power level DAC word at each frequency point.

Up to five user level flatness correction power-offset tables from 2 to 801 frequency points/table can be created and stored in 681XXB memory for recall. The GPIB power meters supported are the Anritsu Model ML4803A and the Hewlett-Packard Models 437B, 438A, and 70100A.

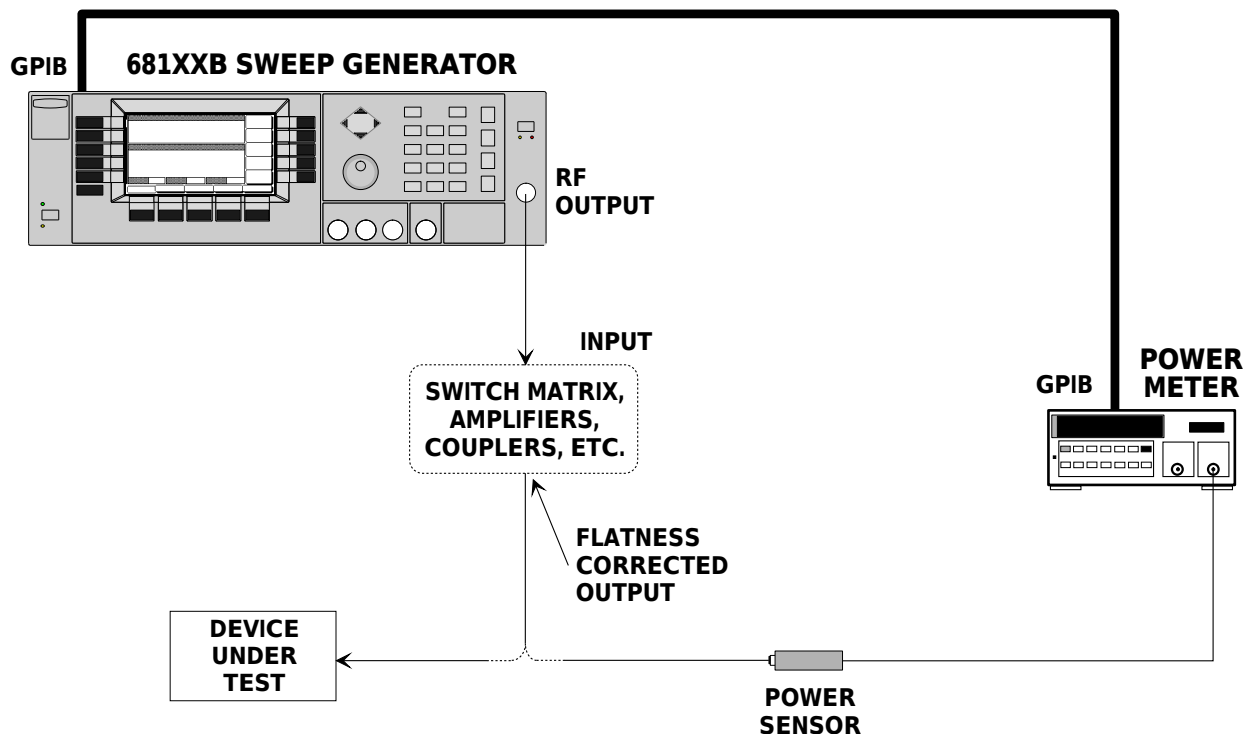

Figure 3-4. Setup for Creating a Power-Offset Table (User Level Flatness Correction)

Equipment Setup

To create a power-offset table for user level flatness correction, connect the equipment (shown in Figure 3-4) as follows:

- Step 1** Using a GPIB cable, connect the Power Meter to the 681XXB.
- Step 2** Calibrate the Power Meter with the Power Sensor.
- Step 3** Connect the Power Sensor to the point in the test setup where the corrected power level is desired.

Power Meter Model and GPIB Address

In order for the 681XXB to control the power meter, the GPIB address and power meter model must be selected from the Configure GPIB menu.

Press **SYSTEM** to go to the System Menu display. At the System Menu display, press **Config**. The System Configuration Menu (shown below) is displayed.

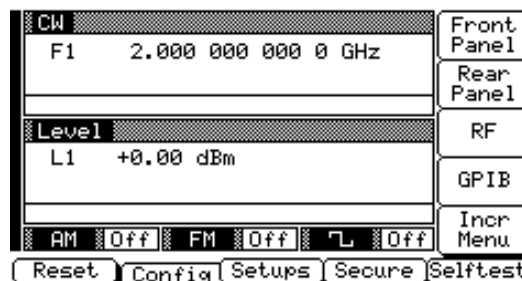

Next, press **GPIB**. The Configure GPIB menu (shown below) is displayed.

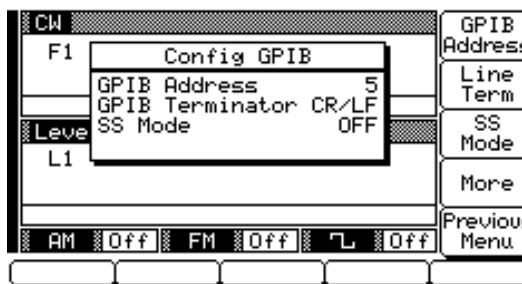

At the Configure GPIB menu, press **More** to go to an additional Configure GPIB menu (shown below).

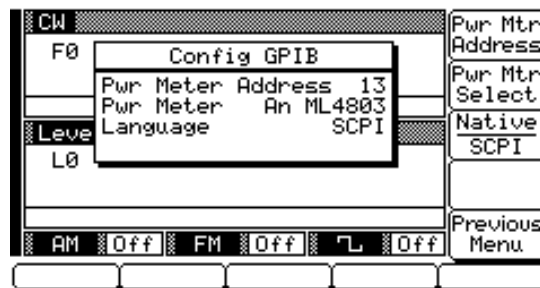

Press **Pwr Mtr Address** to change the address of the power meter on the GPIB (the power meter's default address is 13). Enter the new address, between 1 and 30, using the cursor control key or the data entry key pad and the terminator key

**Hz
ns
ADRS**

The new GPIB address will appear on the display.

Press **Pwr Mtr Select** to select the power meter model being used. (Supported power meters are the Anritsu ML4803A and Hewlett-Packard 437B, 438A, and 70100A.)

Press **Previous Menu** to return to the main Configure GPIB menu display.

At the Configure GPIB menu, press **Previous Menu** to return to the System Configuration menu display.

Creating a Power-Offset Table

The 681XXB must be in CW frequency mode and fixed (non-swept) power level mode in order to create a power-offset table for user level flatness correction.

Place the sweep generator in CW frequency mode by pressing the main menu key

**CW/SWEEP
SELECT**

At the resulting menu display, press **CW**. The 681XXB is now in CW frequency mode.

Place the sweep generator in a fixed power level mode by pressing the main menu key

**LEVEL/ALC
SELECT**

At the resulting menu display, press **Level**. The 681XXB is now in fixed (non-swept) power level mode.

At the Level Menu, press **User Cal**. The User Level Cal menu (shown below) is displayed.

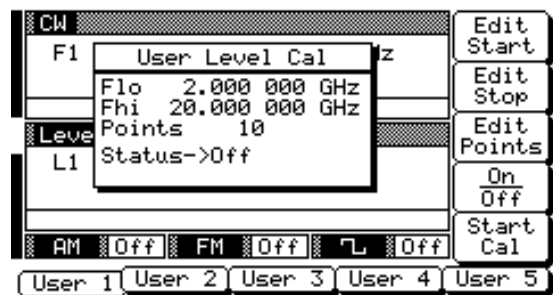

This menu lets you perform the following:

- Create a power-offset table.
- Select a measurement frequency range (edit the start and stop frequency parameters).
- Select the number of points at which correction information is to be taken.
- Apply a power-offset table to the test setup.

First, press the menu soft-key to select the power-offset table (User 1, User 2, User 3, User 4, or User 5) that you wish to create.

Next, set the measurement frequency range by pressing **Edit Start** or **Edit Stop** to open the start (Flo) or stop (Fhi) frequency parameter for editing. Edit the current frequency using the cursor control key or rotary data knob or enter a new value using the keypad and appropriate termination key. When you have finished setting the open parameter, close it by pressing its menu edit soft-key again or by making another menu selection.

Then, select the number of frequency points at which correction information is to be taken by pressing **Edit Points** to open the number-of-points parameter for editing. Edit the current number-of-points using the cursor control key or rotary data knob or enter a new value using the keypad and the

STEPS termination key. (The number of points range is 2 to 801.) When you have finished setting the open number-of-points parameter, close it by pressing **Edit Points** again or by making another menu selection.

Now, press **Start Cal** to begin automatically taking power level correction information at each frequency point. During this process the menu displays the status: Calibrating along with the current measurement frequency point.

NOTE

To terminate the measurement process at any time before completion, press **Abort**.

Once the power-offset table has been created, it is stored in non-volatile memory. The power-offset table is now ready to be applied to the test setup. Disconnect the Power Sensor and Power Meter from the test setup.

Applying User Level Flatness Correction

Whenever user level flatness correction is applied to the test setup by activating the power-offset table, the set power level is delivered at the point where the calibration was performed.

To activate the selected power-offset table and apply user level flatness correction to the test setup, press **On/Off**. The User Level Cal menu will display the status: On.

To turn off the selected power-offset table and remove user level flatness correction from the test setup, press **On/Off** again. The User Level Cal menu will display the status: Off.

Entering a Power-Offset Table via GPIB

User level flatness correction can be applied to the test setup using a power-offset table created from calculated data and entered via the GPIB. Refer to the 681XXB Programming Manual (P/N 10370-10260) for information and instructions on creating a power-offset table and entering it via the GPIB.

USER 1...5

When a power-offset table is selected ON, this status message is displayed on all menu displays to remind the operator that user level flatness correction has been applied to the ALC.

NOTE

The master reset function overwrites all information stored in the non-volatile memory with default values. This includes the nine stored front panel setups.

Erasing the Power-Offset Tables from Memory

The power-offset tables are stored in non-volatile memory. A master reset is required to erase the contents of the tables and reprogram them with default data.

To perform a master reset, proceed as follows:

- Step 1** With the 681XXB in standby, press and hold the RF OUTPUT ON/OFF key.
- Step 2** Press the LINE OPERATE/STANDBY key to turn the instrument on.
- Step 3** When the first menu is displayed (after the start-up display), release the RF OUTPUT ON/OFF key.

The contents of non-volatile memory have now been erased and reprogrammed with default data.

3-12 SIGNAL MODULATION

The sweep generator provides AM, FM, and square wave modulation of the output signal. All modulation modes—AM, FM, and square wave—can be active simultaneously. The following paragraphs provide descriptions and operating instructions for each modulation mode. Use the Amplitude Modulation Mode, Frequency Modulation Mode, and Square Wave Modulation Mode menu maps (Chapter 4, Figures 4-10, 4-11, and 4-12) to follow the menu sequences.

**Amplitude
Modulation
Operating
Modes**

The sweep generator has two AM operation modes—Linear AM and Log AM. In Linear AM mode, sensitivity is 100%/V and the sweep generator accepts a -1V to +1V input signal from an external signal generator. With a -1V input, the RF output shuts off; with a 0V input, the RF output (reference level) is unchanged; and with a +1V input, the RF output is 100% (3 dB) higher than reference level. The amplitude of the RF output changes linearly as the external AM input changes.

In Log AM mode, sensitivity is 10 dB/V and the sweep generator accepts a wider range of input signals from the external signal generator. For every -1V input, the RF output level decreases by 10 dB; for every +1V input, the RF output level increases by 10 dB. The dynamic range of the of positive or negative power levels depends on the sweep generator power level setting.

**Providing
Amplitude
Modulation**

To provide amplitude modulation, first set up the external signal generator, then connect it to either the 681XXB front or rear panel AM IN connector.

Next, press **MODULATION**. At the resulting menu display, press **AM**. The External AM Status Menu (shown below) is displayed.

ERR
This error message is displayed when the external AM modulating signal exceeds the input voltage range. The message “Reduce AM Input Level” also appears at the bottom of the AM status display. AM is turned off until the modulating signal is within the input voltage range.

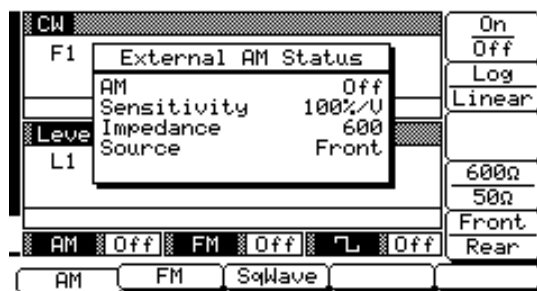

This menu contains an external AM status window that shows the current menu selections. This menu lets you perform the following:

- Turn AM on and off.
- Select the Linear AM (100%/V) or Log AM (10 dB/V) operating mode.
- Select the input connector (front panel or rear panel AM IN) that is connected to the external signal source.
- Select the input impedance (600 Ω or 50 Ω) of the input connector.

Press **On / Off** to turn AM on and off. Both the AM status display and AM modulation status area will reflect your selection.

Press **Log / Linear** to select the AM operating mode. The AM status display will reflect your selection as 10 dB/V (Log) or 100%/V (Linear).

Press **Front / Rear** to select the front panel or rear panel AM IN connector. The AM status display will reflect your selection.

Press **600 Ω / 50 Ω** to select the input impedance of the input connector. The AM status display will reflect your selection.

***Frequency
Modulation
Operating
Modes***

The 681XXB accepts a signal from an external signal generator and provides frequency modulation of the output signal. FM deviation is proportional to the input voltage, with sensitivity (–6 MHz/V, +10 MHz/V, or +20 MHz/V) selectable from a menu.

During FM mode, the YIG phase-lock loop is disabled to allow for greater FM deviations. The frequency accuracy and stability are degraded in this unlocked condition.

The sweep generator has two FM operation modes—Narrow and Wide. In Narrow mode, the FM signal is synthesized by applying the modulating signal to the fine tuning coil of the YIG-tuned oscillator. Narrow FM mode allows maximum deviations of 50 MHz.

In Wide mode, the FM signal is synthesized by applying the modulating signal to the main tuning coil of the YIG-tuned oscillator. Wide FM mode allows maximum deviations of 100 MHz.

***Providing
Frequency
Modulation***

To provide frequency modulation, first set up the external signal generator, then connect it to either the 681XXB front or rear panel FM IN connector.

Next, press **MODULATION**. At the resulting menu display, press **FM**. The External FM Status Menu (shown below) is displayed.

ERR

This error message is displayed when the external FM modulating signal exceeds the input voltage range. The message “Reduce FM Input Level” also appears at the bottom of the FM status display. FM is turned off until the modulating signal is within the input voltage range.

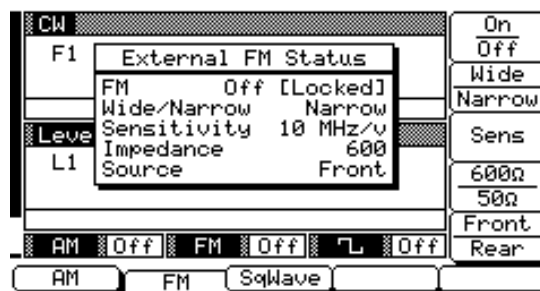

UNLOCKED

When FM is selected ON, this warning message is displayed on all menu displays to remind the operator that the carrier frequency is not phase-locked.

This menu contains an external FM status window that shows the current menu selections. This menu lets you perform the following:

- Turn FM on/off.
- Select the Wide or Narrow FM mode.
- Select FM sensitivity.
- Select the input connector (front panel or rear panel FM IN) that is connected to the external signal source.
- Select the input impedance (600Ω or 50Ω) of the input connector.

Press **On / Off** to turn FM on and off. Both the FM status display and FM modulation status area will reflect your selection.

Press **Wide / Narrow** to select Wide or Narrow FM mode. The FM status display will reflect your selection.

Press **Front/Rear** to select the front or rear panel FM IN connector. The FM status display will reflect your selection.

Press **600Ω/50Ω** to select the input impedance of the input connector. The FM status display will reflect your selection.

To select the FM sensitivity necessary to obtain the desired deviation, press **Sens**. As shown below, the menu display then lists the FM sensitivity choices.

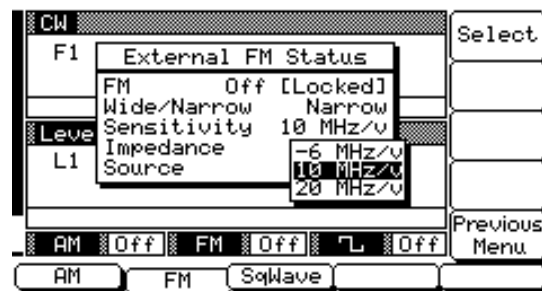

Use the cursor control key to choose the desired FM sensitivity, the press **Select** to enter the selection into memory. The FM status display will reflect your selection.

Press **Previous Menu** to return to the FM Status Menu display.

***Square Wave
Modulation
Operating
Modes***

The 681XXB provides square wave (pulse) modulation of the output signal using modulating signals from either its internal square wave generator or an external signal generator.

The sweep generator's internal square wave generator outputs modulating signals of 400 Hz, 1 kHz, 7.8125 kHz, and 27.8 kHz. The modulating signals are selectable from a menu.

The 681XXB accepts modulating signals from an external signal generator that are TTL-compatible with the minimum pulse width of >5 μ s.

***Providing
Square Wave
Modulation***

The following are the menu selections necessary to provide square wave (pulse) modulation of the output signal using a modulating signal from both the internal and external sources.

Press **MODULATION**. At the resulting menu display, press **SqWave**. The Square Wave Status Menu (shown below) is displayed.

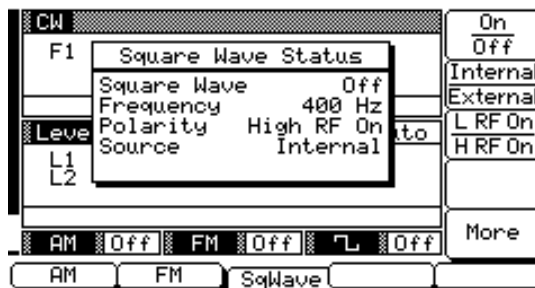

This menu contains the square wave status window that shows the current menu selections. This menu lets you perform the following:

- Turn square wave modulation on/off.
- Select Internal or External source for the modulation signal.
- Select the polarity of the signal (High or Low) that turns the RF on.
- Go to an additional menu (to select the frequency from the internal source or to select the front or rear panel input connector).

Press **On/Off** to turn square wave modulation on and off. Both the Square Wave status display and the Square Wave modulation status area will reflect your selection.

Press **Internal/External** to select the source of the modulating signal. If you select Internal, the status display shows Source as Internal and Frequency lists the actual source frequency. If you select External, the display shows Frequency as Ext (external) and Source as Front or Rear to indicate which input connector is selected.

Press **L RF On/H RF On** to select the polarity of the signal that triggers the RF on.

Press **More** to go to the additional menu.

Internal Source Frequency Selection

If you have selected Internal to use the modulating signal from the internal source, then when you press **More** the menu shown below is displayed.

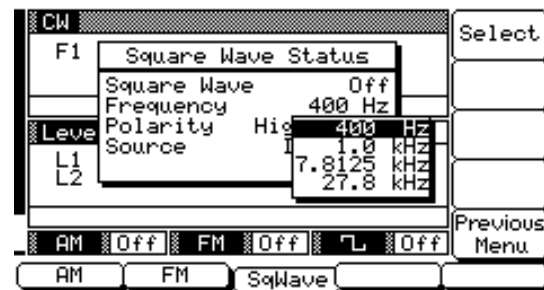

Use the cursor control key to chose the desired modulating signal frequency, then press **Select** to enter the selection into memory. The Square Wave status display will reflect your selection.

Press **Previous Menu** to return to the initial Square Wave Status Menu display.

External Source Input Connector Selection

If you have selected External to use a modulating signal from an external source, then when you press **More** the menu shown below is displayed.

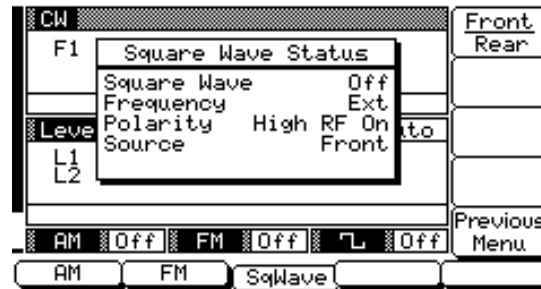

Press **Front/Rear** to select the front or rear panel IN connector. The Square Wave status display shows your selection as Source.

Press **Previous Menu** to return to the initial Square Wave Status Menu display.

**3-13 SYSTEM
CONFIGURATION**

The system configuration function provides menus that let you set or select instrument configuration items; for example, display intensity, polarity of blanking and video marker outputs, RF on or off during retrace or between steps, GPIB address and line terminator, and increment sizes for frequency, power level, and time parameters. Use the System Configuration menu map (Chapter 4, Figure 4-13) to follow the menu sequences.

To go to the System Configuration menu, first press **SYSTEM**. At the System Menu display, press **Config**. The System Configuration Menu (shown below) is displayed.

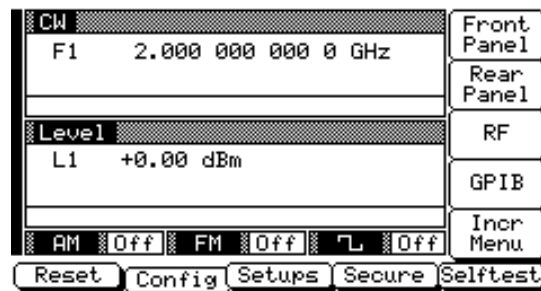

This menu lets you go to the Front Panel, Rear Panel, RF, GPIB, and Increment Configuration menus.

***Configuring
the Front
Panel***

Configuring the front panel of the sweep generator involves adjusting the intensity level of the data display for ease of viewing.

To go to the Configure Front Panel menu from the System Configuration menu, press **Front Panel**. The Configure Front Panel Menu (shown below) is displayed.

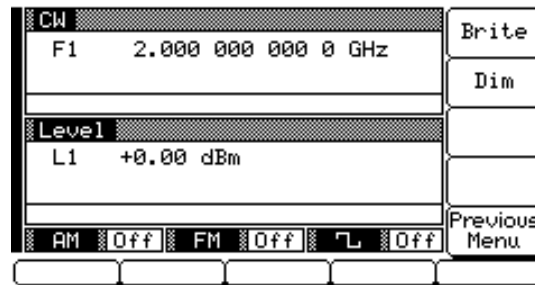

Press **Brite** (repeatedly) to increase the intensity of the data display to the desired level.

Press **Dim** (repeatedly) to decrease the intensity of the data display.

When done, press **Previous Menu** to return to the System Configuration menu.

**Configuring
the Rear
Panel**

Configuring the rear panel of the sweep generator consists of selecting the polarity of the retrace blanking, bandswitch blanking, retrace penlift, and video marker outputs.

To go to the Configure Rear Panel menu from the System Configuration menu, press **Rear Panel** . The Configure Rear Panel Menu (shown below) is displayed.

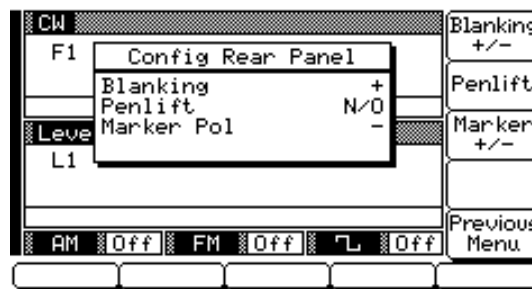

Press **Blanking +/-** to select a +5V or -5V level for the retrace and bandswitch blanking outputs. The retrace blanking signal output is available at the rear panel RETRACE BLANK OUT connector and AUX I/O connector. The bandswitch blanking signal output is available at the rear panel AUX I/O connector. The display will reflect your selection.

Press **Penlift** to select normally-open (N/O) or normally-closed (N/C) contacts on the internal penlift relay. The penlift relay output, available at the rear panel PEN LIFT OUT connector, is used to lift a plotter pen during retrace. The display will reflect your selection.

Press **Marker +/-** to select a +5V or -5V level for the video marker output when video markers are selected ON. The video marker signal output is available at the rear panel MARKER OUT connector and AUX I/O connector. The display will reflect your selection.

When done, press **Previous Menu** to return to the System Configuration menu.

**Configuring
the RF**

Configuring the RF of the 681XXB involves selecting whether the RF should be on or off during retrace and during frequency switching in CW and step modes and selecting whether a sweep triggered by a single or external trigger should rest at the top or bottom of the sweep ramp.

To go to the Configure RF menu from the System Configuration menu, press **RF**. The Configure RF Menu (shown below) is displayed.

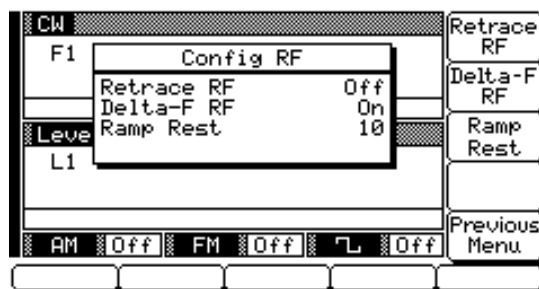

Press **Retrace RF** to select RF On or Off during retrace. The display will reflect your selection.

Press **Delta-F RF** to select RF On or Off during frequency switching in CW or step sweep modes. The display will reflect your selection.

Press **Ramp Rest** to select 0 or 10 for the ramp rest point for sweeps triggered a single or external trigger. 0 indicates that the sweep will rest at the bottom of the sweep ramp; 10 indicates that the sweep will rest at the top of the sweep ramp. The display will reflect your selection.

When done, press **Previous Menu** to return to the System Configuration menu.

**Configuring
the GPIB**

Configuring the GPIB for the sweep generator consists of the following:

- ❑ Selecting a GPIB address and the GPIB line terminator for the sweep generator.
- ❑ Placing the 681XXB in a source lock mode for operation with a WILTRON Model 360B Vector Network Analyzer.
- ❑ Selecting the model and GPIB address for the power meter used to create a user level flatness correction power-offset table.
- ❑ Selecting the external interface language for remote operation of 681XXBs with Option 19.

To go to the Configure GPIB menu from the System Configuration menu, press **GPIB**. The Configure GPIB Menu (shown below) is displayed.

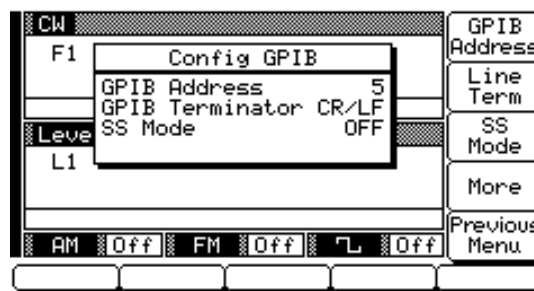

Press **GPIB Address** to change the address of the 681XXB on the bus (the sweep generator's default GPIB address is 5). Enter a new address, between 1 and 30, using the cursor control key or the data entry keypad and the terminator key

**Hz
ns
ADRS**

The new GPIB address will appear on the display.

Press **Line Term** to select a carriage return (CR) or a carriage return and line feed (CR/LF) as the GPIB data delimiter. Consult the GPIB controller's manual to determine which data delimiter is required.

Press **SS Mode** to place the sweep generator in a source lock mode for operation with a WILTRON Model 360B Vector Network Analyzer. (Refer to paragraph 7-4 for information pertaining to operating the 681XXB with a 360B VNA.) Press **SS Mode** again to turn the source lock mode off.

SS MODE

When SS Mode is selected on, this message is displayed (in the frequency mode title bar) on all menu displays to remind the operator that the 681XXB is in a source lock mode.

Press **More** to go to the additional Configure GPIB menu.

Press **Previous Menu** to return to the System Configuration menu.

Additional Configure GPIB Menu

When you press **More** the additional Configure GPIB menu, shown below, is displayed.

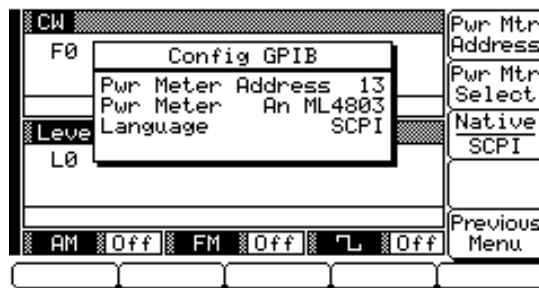

This menu lets you perform the following:

- ❑ Select the model and GPIB address for the power meter that is used to create a user level flatness correction power-offset table. (Refer to page 3-54 for a description of the function.)
- ❑ Select the external interface language for remote operation of 681XXBs with Option 19. (Refer to page 2-9 for more information.)

Press **Pwr Mtr Address** to change the address of the power meter on the GPIB (the power meter's default GPIB address is 13). Enter a new address, between 1 and 30, using the cursor control key or the data entry keypad and the terminator key

**Hz
ns
ADRS**

The new GPIB address will appear on the display.

Press **Pwr Mtr Select** to select the power meter model being used. (Supported power meters are the Anritsu ML4803A and Hewlett-Packard 437B, 438A, and 70100A.)

Press **Native SCPI** to select the external interface language to be used for remote operation of the 681XXB. (Language selection is only available on instruments that have Option 19 installed.)

Press **Previous Menu** to return to the main Configure GPIB menu display.

**Setting
Increment
Sizes**

The Increment menu lets you set the incremental size for editing frequency, power level, and time parameters. When the increment mode is selected on, these parameter values will increase or decrease by the set amount each time the \wedge or \vee pad is pressed or the rotary data knob is turned clockwise or counter-clockwise. The menu also lets you turn the increment mode on and off.

To go to the Increment menu from the System Configuration menu, press **Incr Menu**. The Increment Menu (shown below) is displayed.

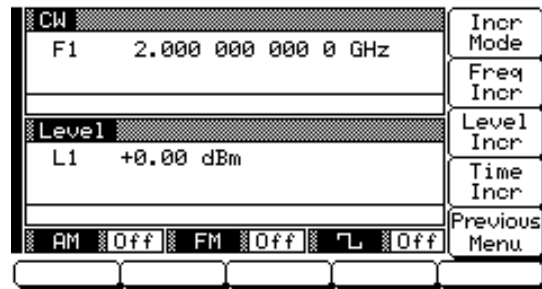

Press **Freq Incr** to open the frequency increment parameter.

Press **Level Incr** to open the power level increment parameter.

Press **Time Incr** to open the time increment parameter.

Open the parameter you wish to change, then edit the current value using the cursor control key or rotary data knob or enter a new value using the key pad and appropriate termination key. When you have finished setting the open parameter, close it by pressing its menu soft-key or by making another menu selection.

Press **Incr Mode** to turn the increment mode on. Press again to turn it off.

When done, press **Previous Menu** to return to the System Configuration menu.

**3-14 SAVING/RECALLING
INSTRUMENT SETUPS**

The 681XXB offers the capability to store up to ten complete front panel setups. The setups are numbered 0 through 9. The following paragraphs describe how to save and recall front panel setups.

***Saving
Setups***

Once you have decided that an instrument setup should be retained for future use, follow the procedure below to save it.

First, press **SYSTEM** to display the System Menu.

Now, press **Setups**. The Setups Menu (shown below) is displayed.

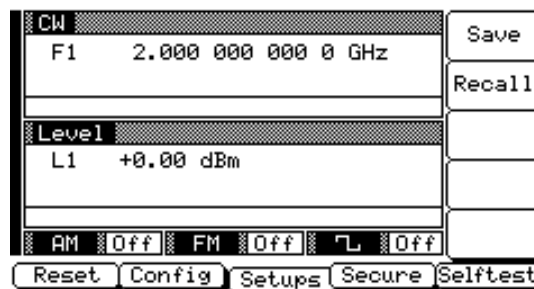

Press **Save**, then enter the desired setup number (between 0 and 9) on the keypad. The setup is now saved.

NOTE

Setup #0 automatically saves the current front panel settings when the instrument is shutdown using the front panel LINE key. Therefore, it is recommended that you use only setups #1 through #9 to save front panel setups.

When instrument shutdown occurs because of main power interruptions, the current front panel settings are not saved.

***Recalling
Setups***

To recall a previously saved setup, first access the Setups Menu as described above.

At the Setups Menu, press **Recall**, then enter the setup number on the keypad.

The instrument resets itself to the recalled configuration.

***Erasing
Stored
Setups***

The front panel setups are stored in non-volatile memory. A master reset is required to erase the contents of the setups and reprogram them with default data.

To perform a master reset, proceed as follows:

- Step 1*** With the 681XXB in standby, press and hold the RF OUTPUT ON/OFF key.
- Step 2*** Press the LINE OPERATE/STANDBY key to turn the instrument on.
- Step 3*** When the first menu is displayed (after the start-up display), release the RF OUTPUT ON/OFF key.

The contents of non-volatile memory have now been erased and reprogrammed with default data.

NOTE

The master reset function overwrites all information stored in the non-volatile memory with default values. This includes the five power-offset tables used for the user level flatness correction function.

3-15 SECURE OPERATION

The 681XXB can be operated in a secure mode of operation. In this secure mode, the display of all frequency, power level, and modulation parameters is disabled during both local (front panel) and remote (GPIB) operations. The instrument will continue to function normally in all other respects. The following paragraphs describe how to place the sweep generator in secure mode and how to return to normal operation.

To place the 681XXB in the secure mode, first press **SYSTEM** to display the System Menu.

Next, press **Secure**. This places the sweep generator in the secure mode and the Secure Menu (shown below) is displayed.

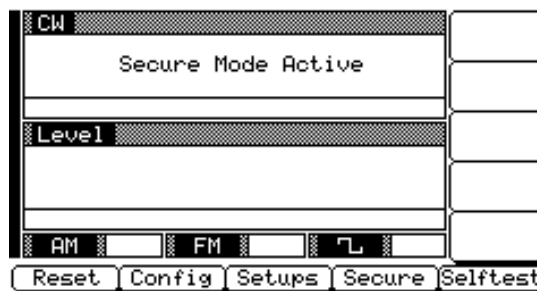

NOTE

During secure mode, all main menu keys and menu soft-keys operate normally. The menu soft-key labels are displayed and change with menu selections. Only the parameter display is disabled.

To return the 681XXB to unsecured (normal) operation, press **SYSTEM**, then press **Reset**.

Chapter 4

Local Operation–Menu Maps

Table of Contents

| | | |
|-----|--------------------------------|-----|
| 4-1 | INTRODUCTION | 4-3 |
| 4-2 | MENU MAP DESCRIPTION | 4-3 |

Chapter 4

Local Operation–Menu Maps

4-1 INTRODUCTION

This chapter provides menu maps that support the 681XXB front panel operating instructions found in Chapter 3. It includes menu maps for all of the frequency, power level, and modulation modes of operation. In addition, a menu map for system configuration is also provided.

4-2 MENU MAP DESCRIPTION

A menu map shows the menu key selections and instrument menu displays for a particular mode of sweep generator operation. The menu displays are shown as they appear on the instrument and are linked together to show the sequence of menu selection. A brief description of the function of each menu's soft-keys is provided. If a menu soft-key selects another menu, then it is shown linked to that menu. Figure 4-1, on page 4-5, is a sample menu map annotated to identify the key elements.

The following is a list of the menu maps contained in this chapter:

| Figure | Title | Page |
|---------------|--|-------------|
| 4-1 | Sample Menu Map | 4-5 |
| 4-2 | CW Frequency Mode Menu Map | 4-6 |
| 4-3 | Analog Sweep Frequency Mode Menu Map | 4-7 |
| 4-4 | Step Sweep Frequency Mode Menu Map | 4-8 |
| 4-5 | Manual Sweep Frequency Mode Menu Map | 4-9 |
| 4-6 | Fixed Power Level Mode Menu Map | 4-10 |
| 4-7 | CW Power Sweep Mode Menu Map | 4-11 |
| 4-8 | Sweep Frequency/Step Power Mode Menu Map | 4-12 |
| 4-9 | Leveling Modes Menu Map | 4-13 |
| 4-10 | Amplitude Modulation Mode Menu Map | 4-14 |
| 4-11 | Frequency Modulation Mode Menu Map | 4-15 |
| 4-12 | Square Wave Modulation Mode Menu Map | 4-16 |
| 4-13 | System Configuration Menu Map | 4-17 |

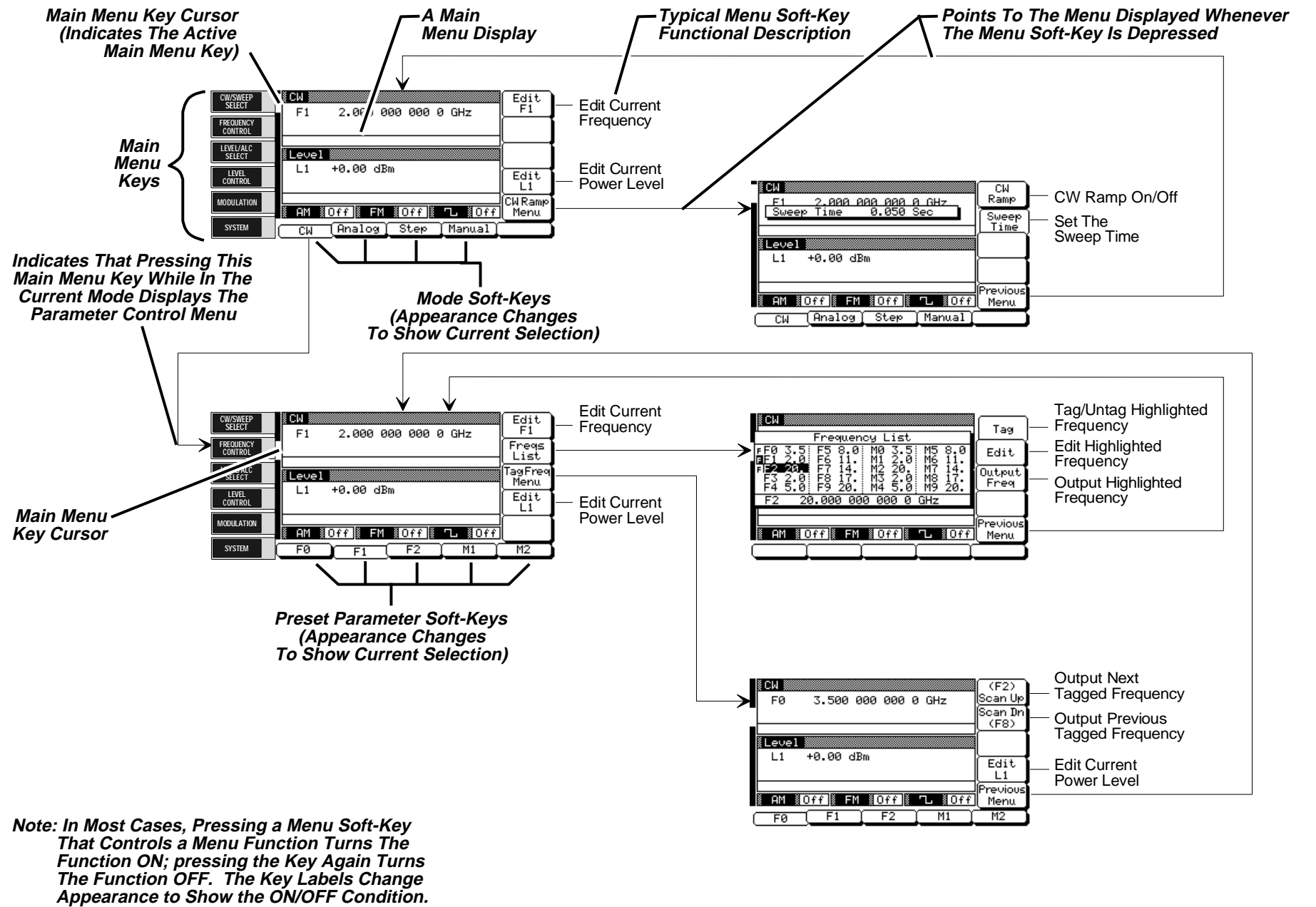
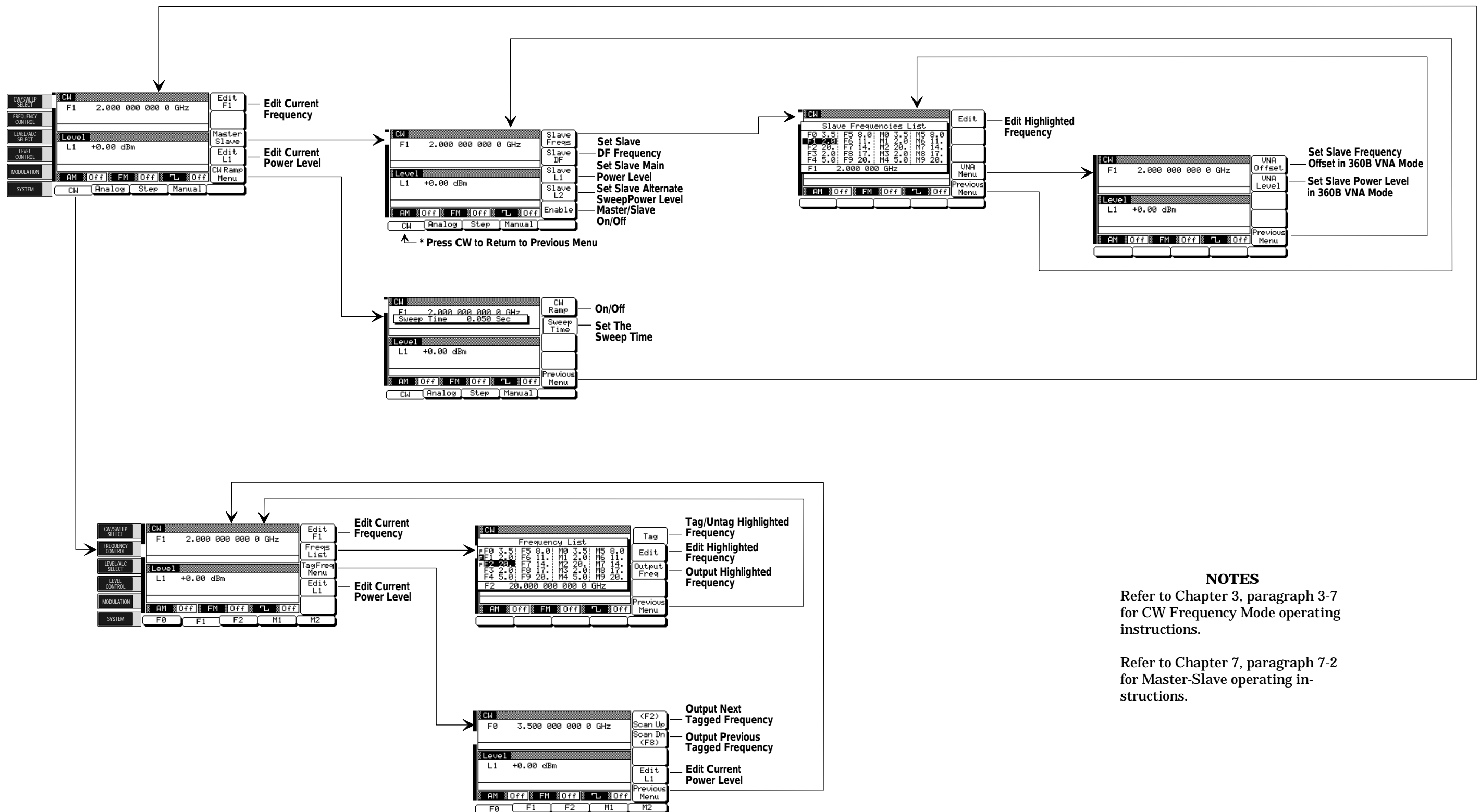

Figure 4-1. Sample Menu Map (Annotated)



NOTES
Refer to Chapter 3, paragraph 3-7 for CW Frequency Mode operating instructions.

Refer to Chapter 7, paragraph 7-2 for Master-Slave operating instructions.

Figure 4-2. CW Frequency Mode Menu Map

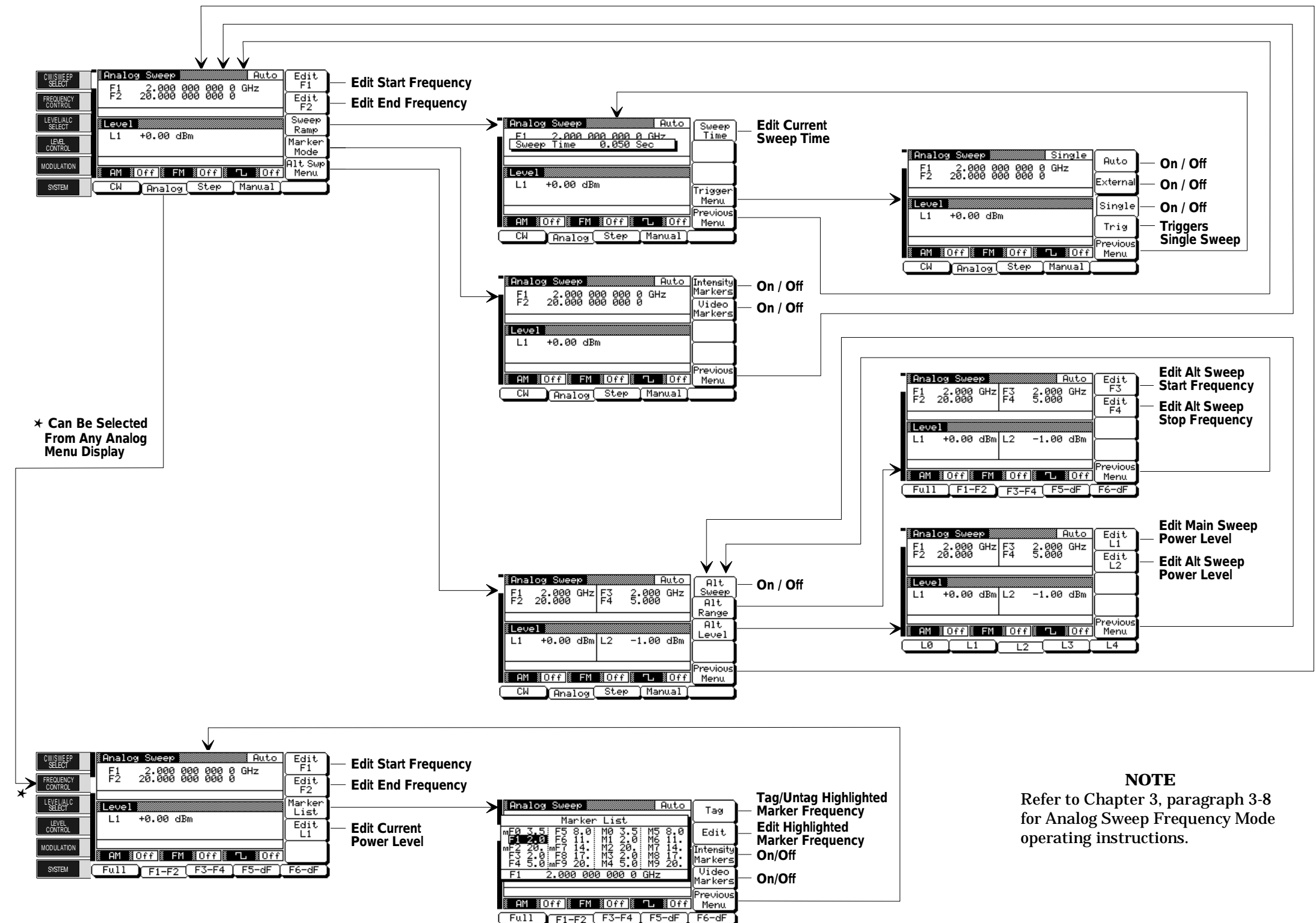

Figure 4-3. Analog Sweep Frequency Mode Menu Map

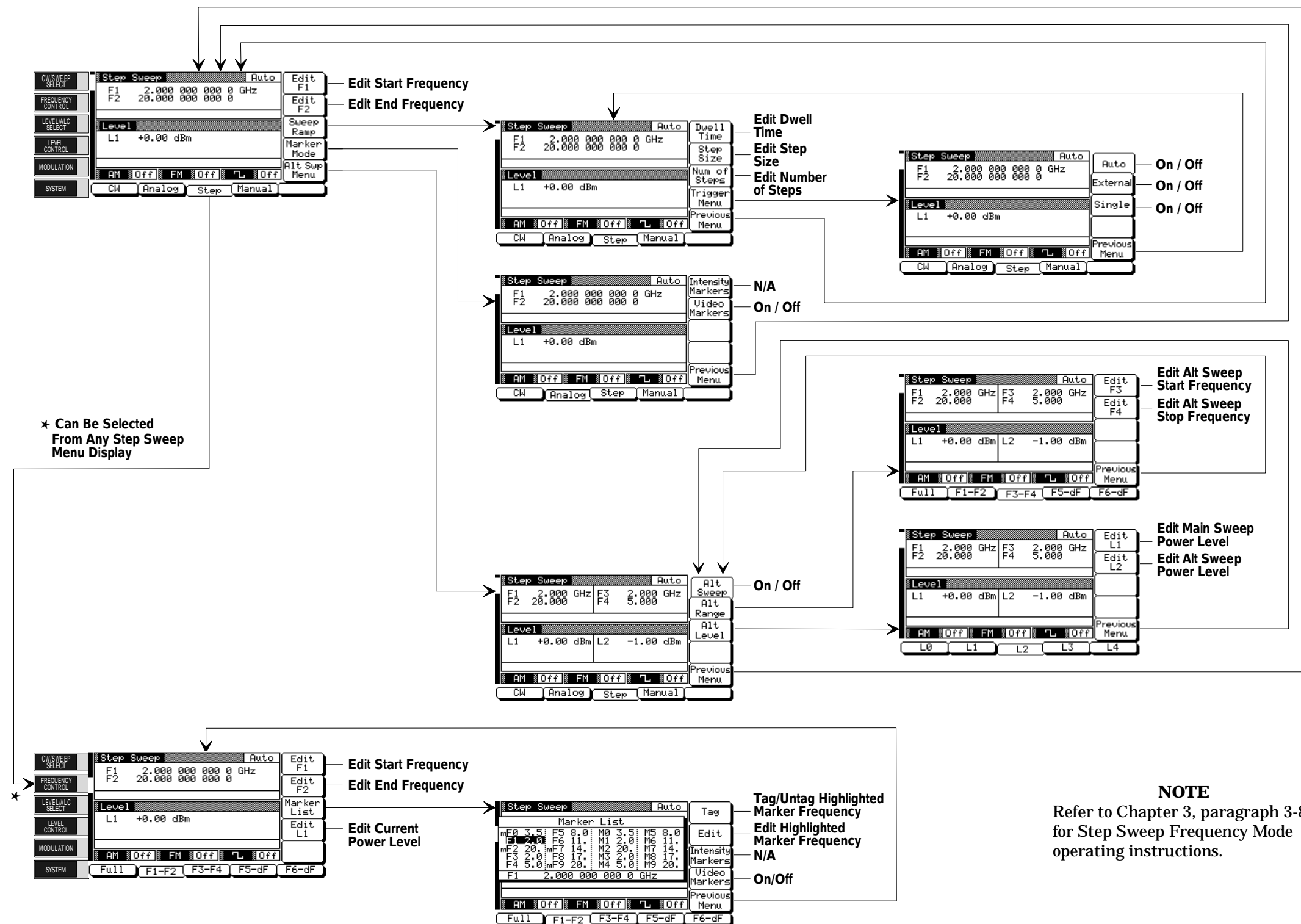
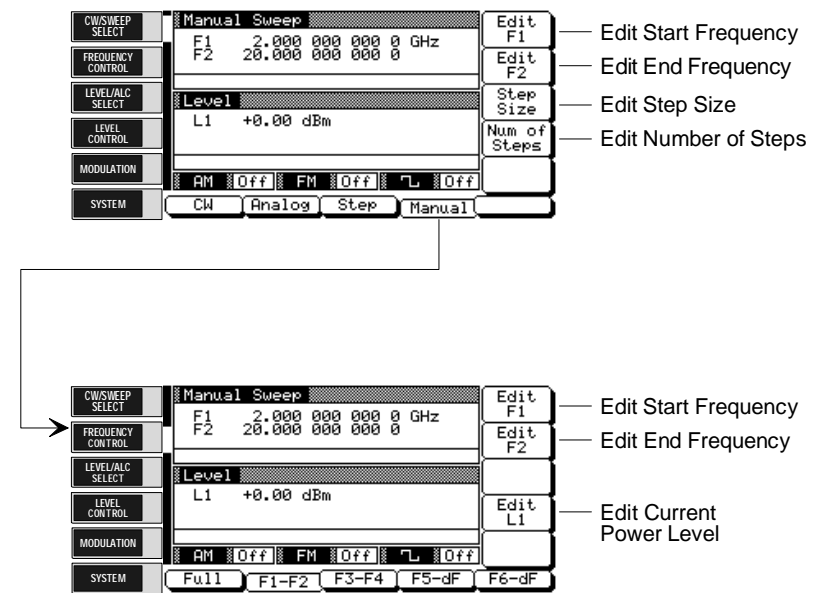
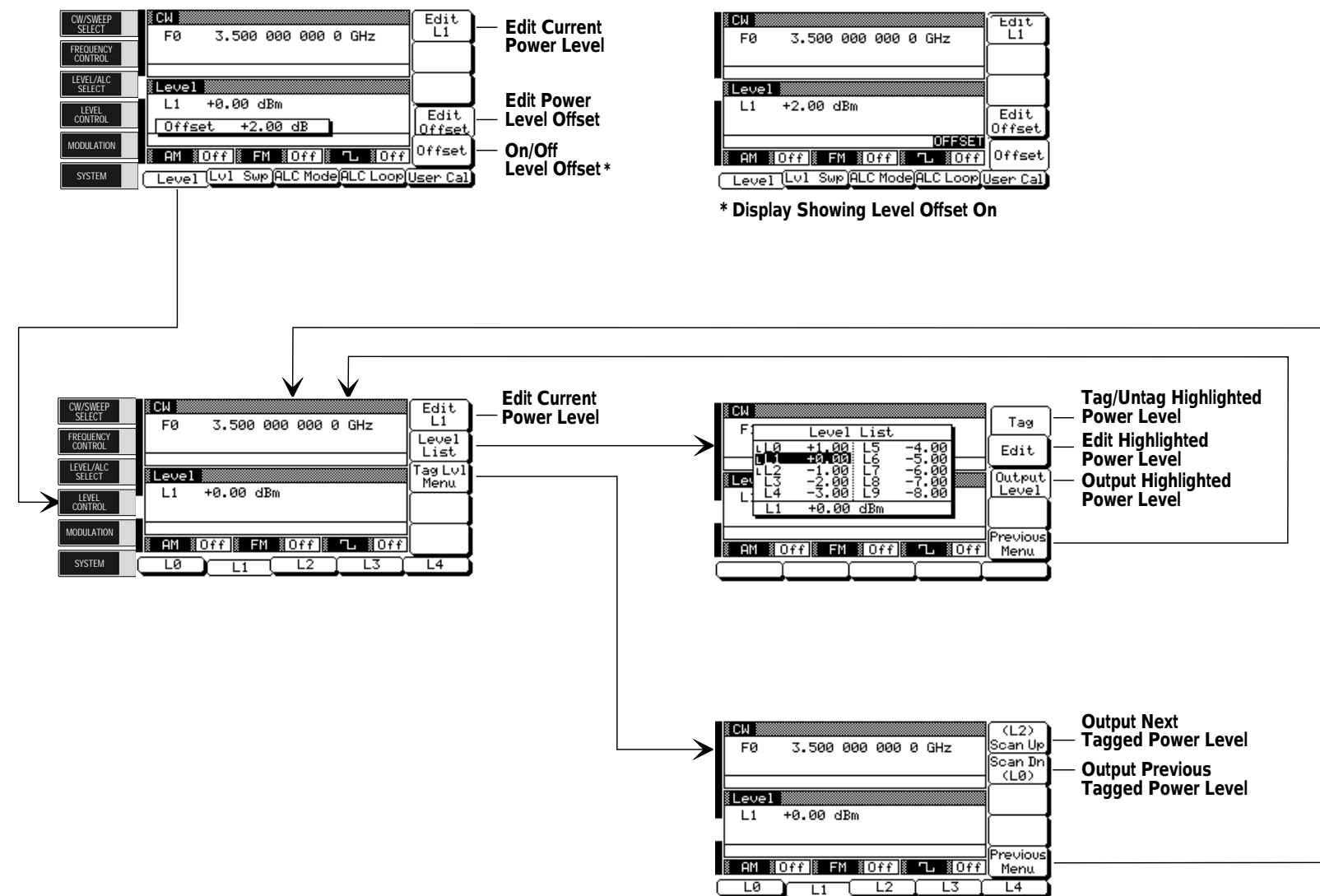

Figure 4-4. Step Sweep Frequency Mode Menu Map



NOTE
Refer to Chapter 3, paragraph 3-8
for Manual Sweep Frequency Mode
operating instructions.

Figure 4-5. Manual Sweep Frequency Mode
Menu Map



NOTE
Refer to Chapter 3, paragraph 3-9 for Fixed Power Level Mode operating instructions.

Figure 4-6. Fixed Power Level Mode Menu Map

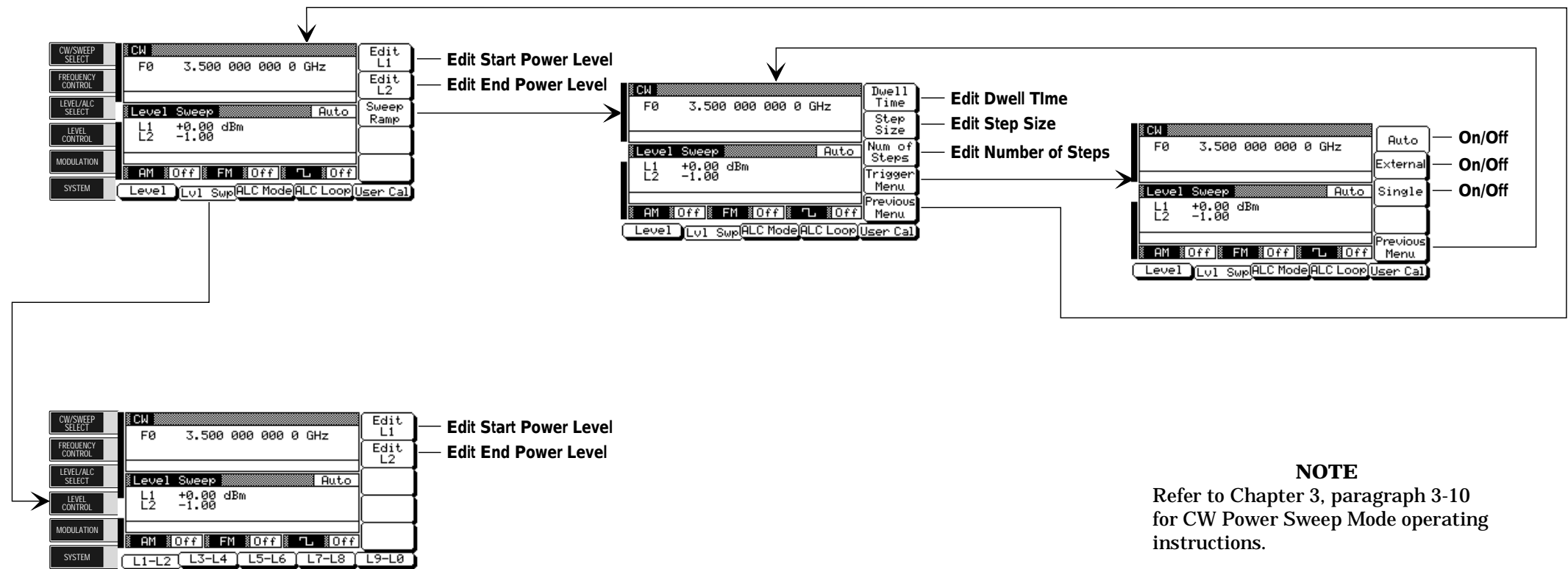

NOTE
Refer to Chapter 3, paragraph 3-10
for CW Power Sweep Mode operating
instructions.

Figure 4-7. CW Power Sweep Mode Menu Map

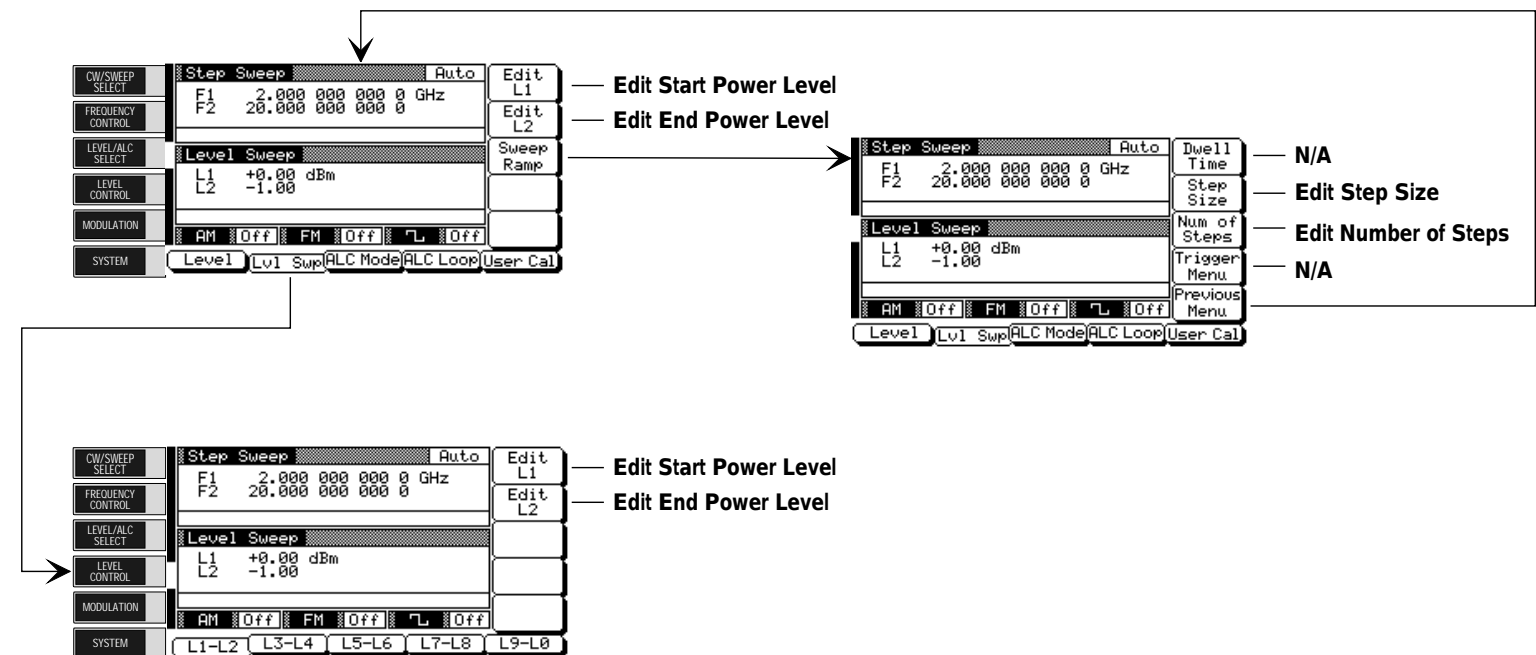

NOTE
Refer to Chapter 3, paragraph 3-10 for Sweep Frequency/Step Power Mode operating instructions.

Figure 4-8. Sweep Frequency/Step Power Mode Menu Map

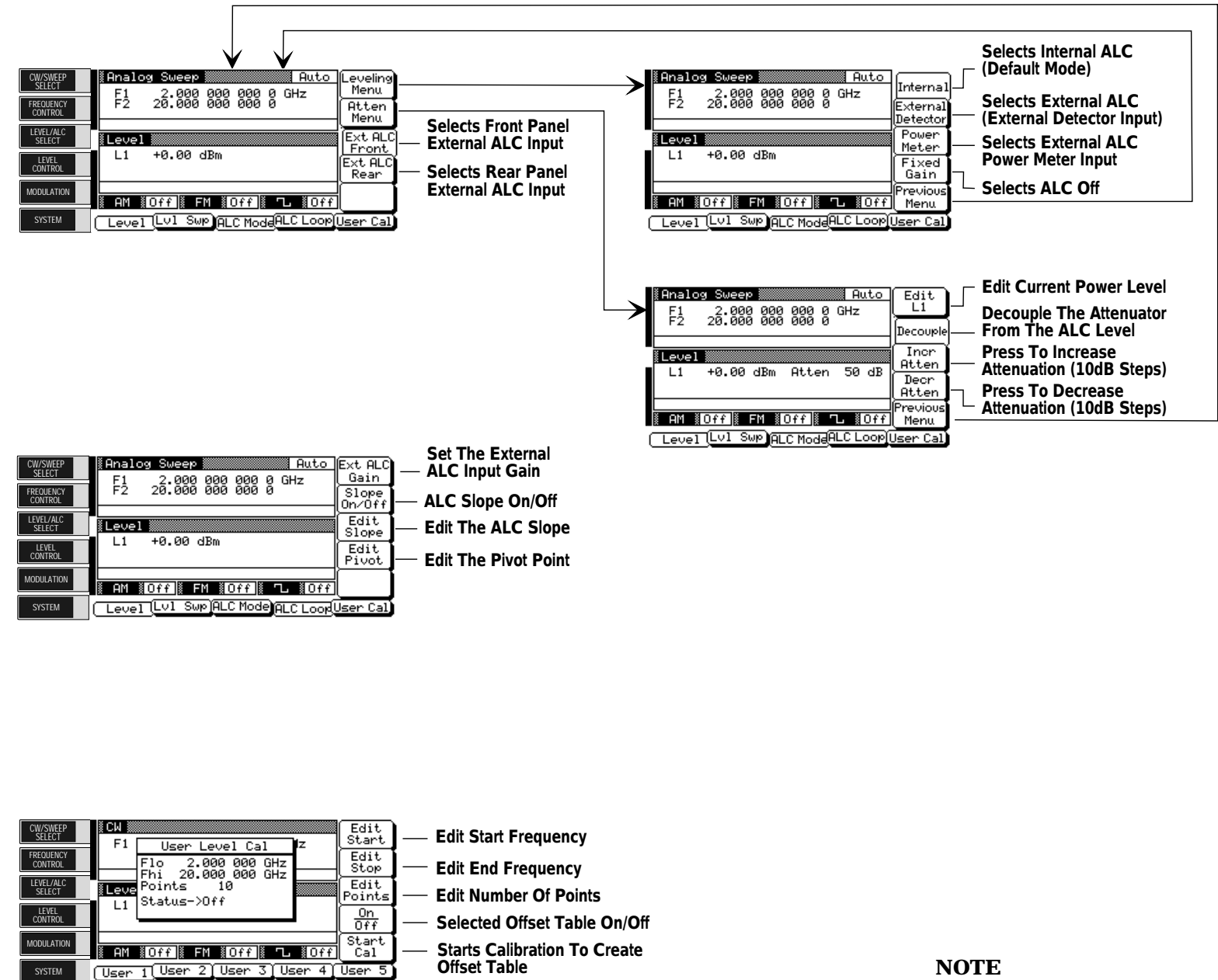

NOTE
Refer to Chapter 3, paragraph 3-11 for Leveling Modes operating instructions.

Figure 4-9. Leveling Modes Menu Map

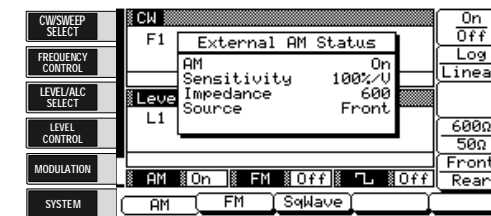
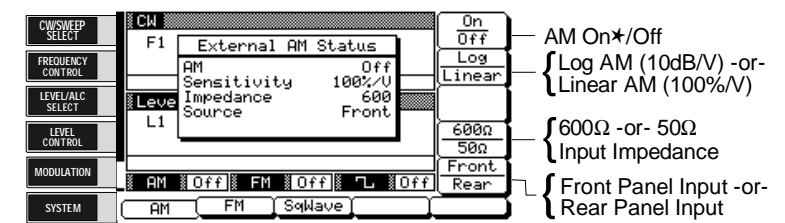

* Display Showing AM Selected On

NOTE
Refer to Chapter 3, paragraph 3-12
for AM Mode operating instructions.

Figure 4-10. Amplitude Modulation Mode
Menu Map

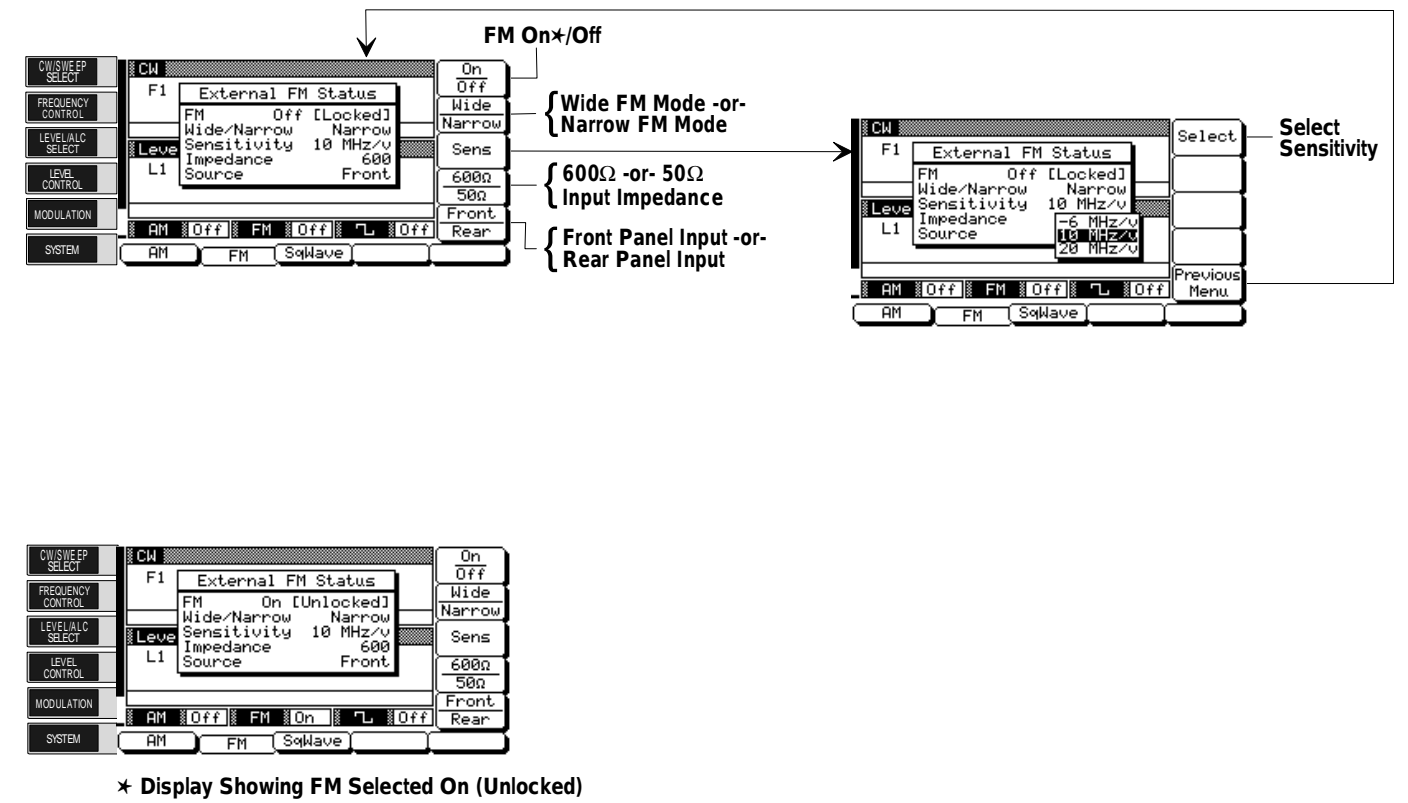

NOTE
Refer to Chapter 3, paragraph 3-12
for FM Mode operating instructions.

Figure 4-11. Frequency Modulation Mode
Menu Map

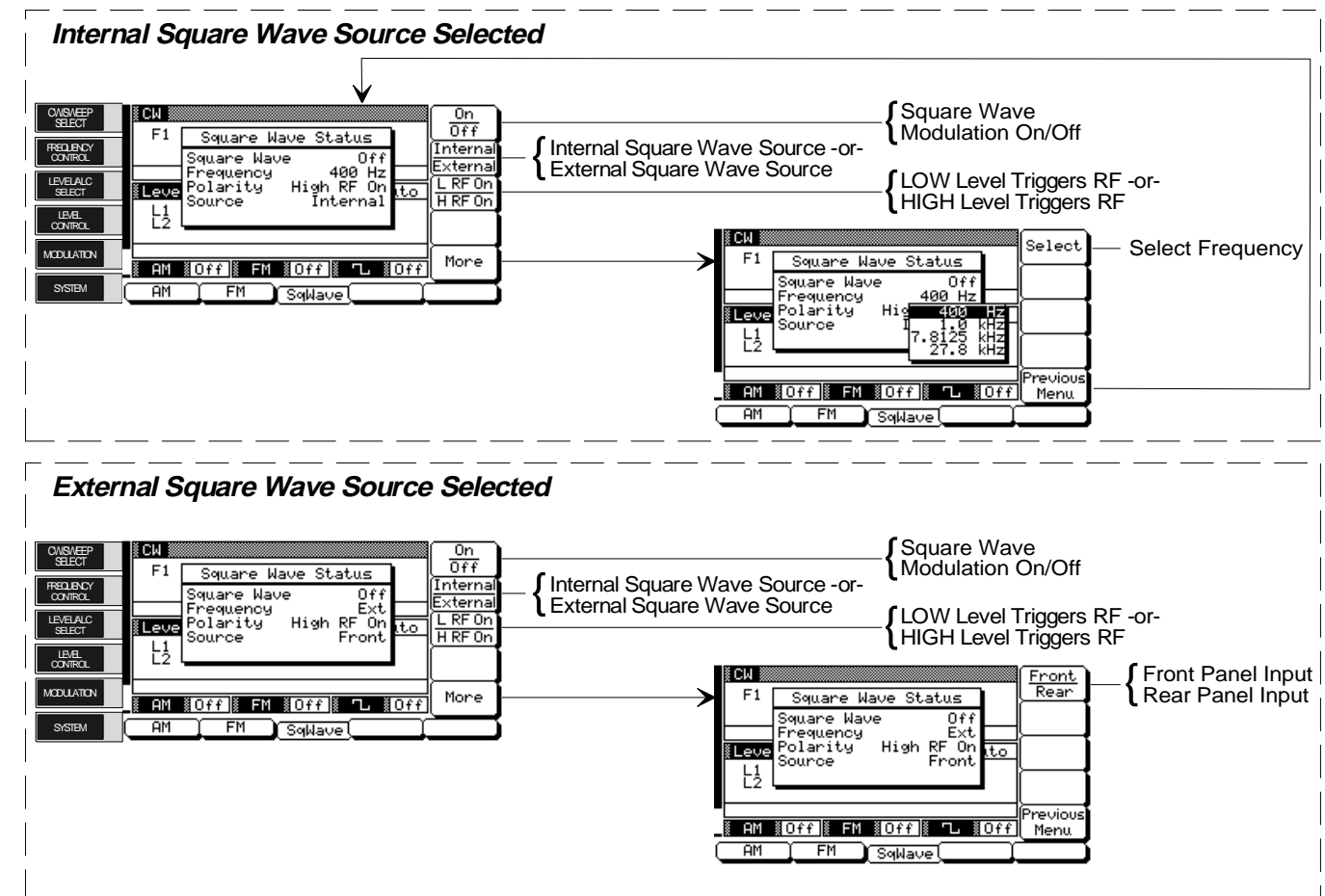

NOTE

Refer to Chapter 3, paragraph 3-12 for Square Wave Modulation Mode operating instructions.

Figure 4-12. Square Wave Modulation Mode Menu Map

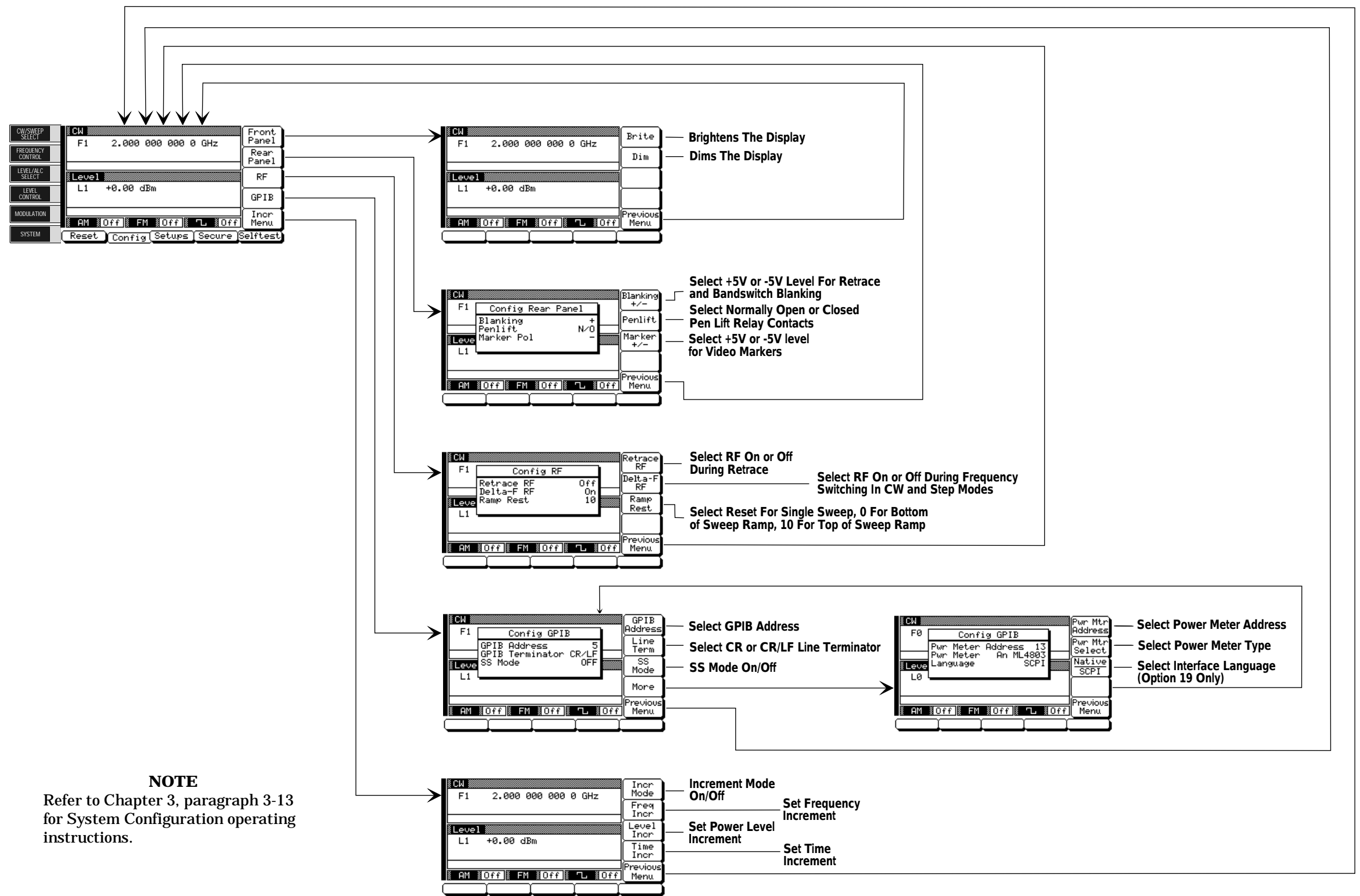

Figure 4-13. System Configuration Menu Map

Chapter 5

Operation Verification

Table of Contents

| | | |
|-----|---|------|
| 5-1 | INTRODUCTION | 5-3 |
| 5-2 | TEST EQUIPMENT | 5-3 |
| 5-3 | TEST RECORDS | 5-3 |
| 5-4 | INITIAL 681XXB CHECKOUT | 5-4 |
| | Power Up | 5-4 |
| | Self Test | 5-4 |
| | Resetting the 681XXB | 5-4 |
| | Warmup Time | 5-4 |
| 5-5 | CW FREQUENCY ACCURACY TEST | 5-5 |
| | Test Setup | 5-5 |
| | Test Procedure | 5-6 |
| 5-6 | POWER LEVEL TESTS | 5-11 |
| | Test Setup | 5-11 |
| | Power Level Accuracy Test Procedure | 5-12 |
| | Power Level Flatness Test Procedure | 5-13 |

Chapter 5

Operation Verification

5-1 INTRODUCTION

This chapter contains three operation verification tests that can be used to verify Series 681XXB Synthesized Sweep Generator operation.

Setup instructions and performance procedures are included for each test. The results can be compared with the specified limits that are shown on the test record forms that are provided for each test.

5-2 TEST EQUIPMENT

Table 5-1 lists the recommended test equipment for performing the operation verification tests in this chapter.

Table 5-1. Recommended Test Equipment

| Instrument | Critical Specification | Recommended Manufacturer/Model |
|--|---|---|
| Frequency Counter, with External Mixer | <i>Range:</i> 0.01 to 40 GHz <i>Input Z:</i> 50Ω <i>Resolution:</i> 1 Hz <i>Other:</i> External Time Base Input | EIP Microwave, Inc. Model 578A, with External Mixer: Option 91 (26.5 to 40 GHz) |
| Power Meter, with Power Sensor | <i>Range:</i> -30 to +20 dBm (1μW to 100 mW) | Hewlett-Packard Model 437B, with Power Sensor: HP 8487A (0.01 to 50 GHz) |
| Oscilloscope | <i>Bandwidth:</i> DC to 150 MHz <i>Vertical Sensitivity:</i> 2 mV/division <i>Horiz Sensitivity:</i> 50 ns/division | Tektronix, Inc. Model 2445 |

5-3 TEST RECORDS

Tables 5-2 and 5-3 contain test record forms that can be photocopied and used to record the results of operational verification testing of your 681XXB. These tables are included as part of the operational verification test procedures and contain test information for all 681XXB models.

**5-4 INITIAL 681XXB
CHECKOUT**

Before starting the operation verification tests in this chapter, perform an initial checkout of the 681XXB to be tested. This initial checkout consists of applying power to the sweep generator, verifying that it passes self-test, and resetting it to the factory default parameters.

Power Up

First, verify that the rear panel line voltage selector is set for the correct line voltage, then connect the 681XXB to the power source. This automatically places the sweep generator in operation (front panel OPERATE LED on).

During power up, the sweep generator loads its operating program then returns to the exact setup it was in when last turned off.

Self Test

Next, perform a self-test of the signal generator to insure proper operation of the instrument PCBs and other internal assemblies.

To self-test the signal generator, press **SYSTEM** . Then, press the System Menu soft-key **Selftest** . When the self-test is complete, the sweep generator displays the main CW menu.

NOTE

Error conditions detected during self-test are displayed as error messages on the data display. They should be corrected before continuing. Refer to Chapter 6 for a listing of error messages and descriptions.

**Resetting the
681XXB**

The sweep generator should be reset to the factory-selected default parameters before commencing operation verification testing.

To reset the 681XXB, first press **SYSTEM** , then press **Reset** . The sweep generator resets to the CW frequency mode and displays the CW Menu.

**Warmup
Time**

When the sweep generator is turned on, allow one hour of warmup time before performing operational verification testing. This will assure stable operation of the instrument.

**5-5 CW FREQUENCY
ACCURACY TEST**

The following test verifies that the CW frequency output of the sweep generator is within accuracy specifications. Table 5-2, beginning on page 5-7, contains test records that you can copy and use to record test results for this test. Test records for standard 681XXB models are contained in Table 5-2A ; test records for 681XXB models with Option 11 are contained in Table 5-2B.

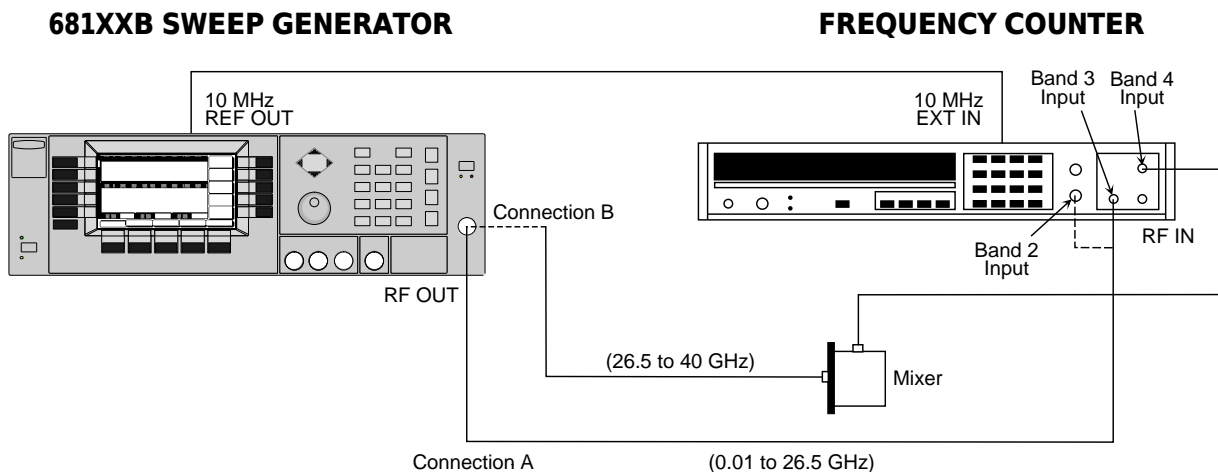

Figure 5-1. Equipment Setup for CW Frequency Accuracy Test

Test Setup

Connect the equipment, shown in Figure 5-1, as follows:

- Step 1** Connect the 681XXB rear panel 10 MHz REF OUT to the Frequency Counter 10 MHz External Reference input. If the Frequency Counter has an INT/EXT toggle switch, ensure the switch is set to EXT.
- Step 2** Connect the 681XXB RF OUTPUT to the Frequency Counter RF Input as follows:
 - a.** For measuring frequencies of 0.01 to 1.0 GHz, connect to the Band 2 input (Connection A).
 - b.** For measuring frequencies of 1.0 to 26.5 GHz, connect to the Band 3 input (Connection A).
 - c.** For measuring frequencies of 26.5 to 40.0 GHz, connect to the Band 4 input via the Option 91 waveguide mixer (Connection B).

**Test
Procedure**

The following procedure tests both the coarse and fine loops to verify the accuracy of the CW frequency output.

- Step 1** Set up the 681XXB as follows:
- a. Reset the instrument by pressing **SYSTEM**, then **RESET**. Upon reset, the CW Menu is displayed.
 - b. Press **Edit F1** to open the current frequency parameter for editing.

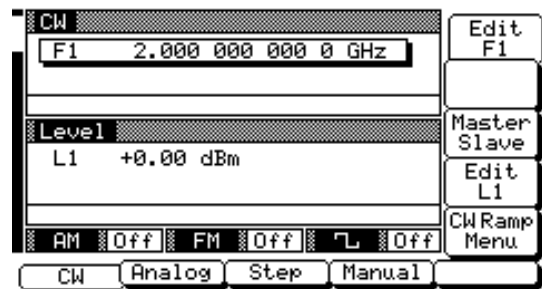

- c. Set F1 to the first test frequency for the model being tested (Table 5-2A is the test record for standard models; Table 5-2B is for models with Option 11).

Step 2 Verify that the Frequency Counter reading meets specifications (± 100 Hz of the value shown on the test record for standard models; ± 10 Hz for instruments with Option 11).

Step 3 Record the Frequency Counter reading on the test record (Table 5-2A or Table 5-2B).

NOTE

The Frequency Counter reading is typically within ± 1 Hz. Differences of a few Hertz can be caused by noise or counter limitations. Differences of $\geq \pm 100$ Hz ($\geq \pm 10$ Hz for instruments with Option 11) indicate a frequency synthesis problem.

Step 4 Set F1 to the next test frequency on the test record and record the Frequency Counter reading.

Step 5 Repeat step 4 until all frequencies listed on the test record have been recorded.

**OPERATION
VERIFICATION**

**CW FREQUENCY
ACCURACY TEST**

Table 5-2A. CW Frequency Accuracy Test Record (for Standard Models) (1 of 2)

| Model 681 __ B | Serial No. _____ | Date _____ |
|------------------------|------------------|------------------------|
| 68137B / 68147B | | 68153B / 68159B |
| 2.000 000 000* | _____ | 2.000 000 000* _____ |
| 5.000 000 000 | _____ | 5.000 000 000 _____ |
| 8.000 000 000 | _____ | 8.000 000 000 _____ |
| 11.000 000 000 | _____ | 11.000 000 000 _____ |
| 14.000 000 000 | _____ | 14.000 000 000 _____ |
| 17.000 000 000 | _____ | 17.000 000 000 _____ |
| 20.000 000 000 | _____ | 20.000 000 000 _____ |
| | | 23.000 000 000 _____ |
| | | 26.500 000 000 _____ |
| 2.000 001 000 | _____ | |
| 2.000 002 000 | _____ | |
| 2.000 003 000 | _____ | 2.000 001 000 _____ |
| 2.000 004 000 | _____ | 2.000 002 000 _____ |
| 2.000 005 000 | _____ | 2.000 003 000 _____ |
| 2.000 006 000 | _____ | 2.000 004 000 _____ |
| 2.000 007 000 | _____ | 2.000 005 000 _____ |
| 2.000 008 000 | _____ | 2.000 006 000 _____ |
| 2.000 009 000 | _____ | 2.000 007 000 _____ |
| 2.000 010 000 | _____ | 2.000 008 000 _____ |
| | | 2.000 009 000 _____ |
| | | 2.000 010 000 _____ |

* Specification for all frequencies listed above is ± 100 Hz. All frequencies are in GHz.

**OPERATION
VERIFICATION**

**CW FREQUENCY
ACCURACY TEST**

Table 5-2A. CW Frequency Accuracy Test Record (for Standard Models) (2 of 2)

| Model 681 __ B | Serial No. _____ | Date _____ |
|------------------------|------------------|------------|
| 68163B / 68169B | | |
| 2.000 000 000* | _____ | |
| 5.000 000 000 | _____ | |
| 8.000 000 000 | _____ | |
| 11.000 000 000 | _____ | |
| 14.000 000 000 | _____ | |
| 17.000 000 000 | _____ | |
| 20.000 000 000 | _____ | |
| 23.000 000 000 | _____ | |
| 26.000 000 000 | _____ | |
| 29.000 000 000 | _____ | |
| 32.000 000 000 | _____ | |
| 35.000 000 000 | _____ | |
| 38.000 000 000 | _____ | |
| 40.000 000 000 | _____ | |
| | | |
| 2.000 001 000 | _____ | |
| 2.000 002 000 | _____ | |
| 2.000 003 000 | _____ | |
| 2.000 004 000 | _____ | |
| 2.000 005 000 | _____ | |
| 2.000 006 000 | _____ | |
| 2.000 007 000 | _____ | |
| 2.000 008 000 | _____ | |
| 2.000 009 000 | _____ | |
| 2.000 010 000 | _____ | |

* Specification for all frequencies listed above is ± 100 Hz. All frequencies are in GHz.

**OPERATION
VERIFICATION**

**CW FREQUENCY
ACCURACY TEST**

Table 5-2B. CW Frequency Accuracy Test Record (for Models with Option 11) (1 of 2)

| Model 681 __ B | Serial No. _____ | Date _____ |
|------------------------|------------------|------------------------|
| 68137B / 68147B | | 68153B / 68159B |
| 2.000 000 000 0* | _____ | 2.000 000 000 0* _____ |
| 5.000 000 000 0 | _____ | 5.000 000 000 0 _____ |
| 8.000 000 000 0 | _____ | 8.000 000 000 0 _____ |
| 11.000 000 000 0 | _____ | 11.000 000 000 0 _____ |
| 14.000 000 000 0 | _____ | 14.000 000 000 0 _____ |
| 17.000 000 000 0 | _____ | 17.000 000 000 0 _____ |
| 20.000 000 000 0 | _____ | 20.000 000 000 0 _____ |
| | | 23.000 000 000 0 _____ |
| | | 26.500 000 000 0 _____ |
| 2.000 000 100 0 | _____ | |
| 2.000 000 200 0 | _____ | |
| 2.000 000 300 0 | _____ | 2.000 000 100 0 _____ |
| 2.000 000 400 0 | _____ | 2.000 000 200 0 _____ |
| 2.000 000 500 0 | _____ | 2.000 000 300 0 _____ |
| 2.000 000 600 0 | _____ | 2.000 000 400 0 _____ |
| 2.000 000 700 0 | _____ | 2.000 000 500 0 _____ |
| 2.000 000 800 0 | _____ | 2.000 000 600 0 _____ |
| 2.000 000 900 0 | _____ | 2.000 000 700 0 _____ |
| 2.000 001 000 0 | _____ | 2.000 000 800 0 _____ |
| | | 2.000 000 900 0 _____ |
| | | 2.000 001 000 0 _____ |

* Specification for all frequencies listed above is ± 10 Hz. All frequencies are in GHz.

**OPERATION
VERIFICATION**

**CW FREQUENCY
ACCURACY TEST**

Figure 5-2B. CW Frequency Accuracy Test Record (for Models with Option 11) (2 of 2)

| Model 681 __ B | Serial No. _____ | Date _____ |
|------------------------|------------------|------------|
| 68163B / 68169B | | |
| 2.000 000 000 0* | _____ | |
| 5.000 000 000 0 | _____ | |
| 8.000 000 000 0 | _____ | |
| 11.000 000 000 0 | _____ | |
| 14.000 000 000 0 | _____ | |
| 17.000 000 000 0 | _____ | |
| 20.000 000 000 0 | _____ | |
| 23.000 000 000 0 | _____ | |
| 26.000 000 000 0 | _____ | |
| 29.000 000 000 0 | _____ | |
| 32.000 000 000 0 | _____ | |
| 35.000 000 000 0 | _____ | |
| 38.000 000 000 0 | _____ | |
| 40.000 000 000 0 | _____ | |
| | | |
| 2.000 000 100 0 | _____ | |
| 2.000 000 200 0 | _____ | |
| 2.000 000 300 0 | _____ | |
| 2.000 000 400 0 | _____ | |
| 2.000 000 500 0 | _____ | |
| 2.000 000 600 0 | _____ | |
| 2.000 000 700 0 | _____ | |
| 2.000 000 800 0 | _____ | |
| 2.000 000 900 0 | _____ | |
| 2.000 001 000 0 | _____ | |

* Specification for all frequencies listed above is ± 10 Hz. All frequencies are in GHz.

**5-6 POWER LEVEL
ACCURACY AND
FLATNESS TESTS**

These tests verify that the power level accuracy and flatness of the 681XXB meet specifications. Table 5-3, beginning on page 5-17, contains test records that you can copy and use to record test results for these tests. Test records are provided for each 681XXB model configuration.

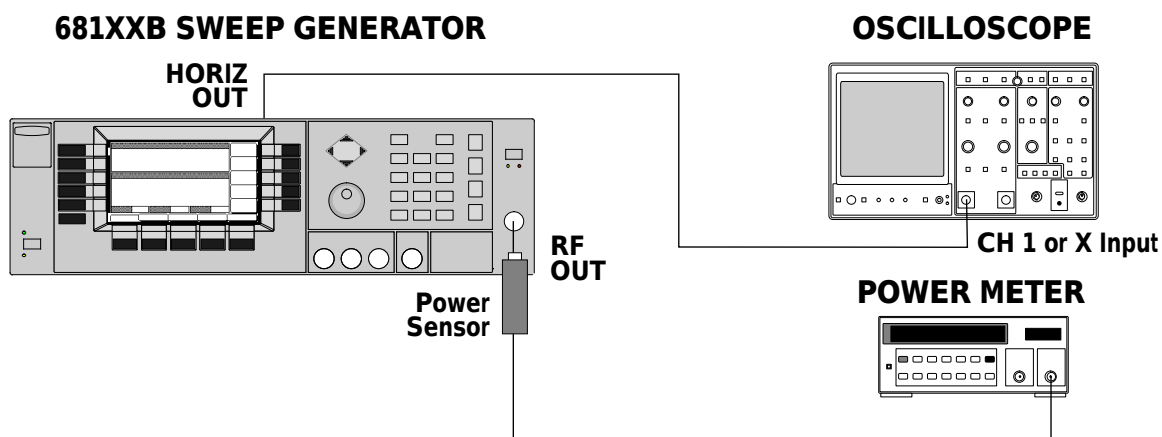

Figure 5-2. Equipment Setup for Power Level Accuracy and Flatness Tests

Test Setup

Connect the equipment, shown in Figure 5-2, as follows:

- Step 1** Calibrate the Power Meter with the Power Sensor.
- Step 2** Connect the Power Sensor to the RF OUTPUT of the 681XXB.
- Step 3** Connect the 681XXB rear panel HORIZ OUT to the Oscilloscope CH.1 input (X input).

NOTE

Before starting these procedures, locate the test record in Table 5-3 for the particular 681XXB model configuration being tested.

**Power Level
Accuracy
Test Procedure**

Power level accuracy is checked by stepping the power down in 1 dB increments from its maximum rated power level.

Step 1 Set up the 681XXB as follows:

- a. Reset the instrument by pressing **SYSTEM**, then **Reset**. The CW Menu is displayed.

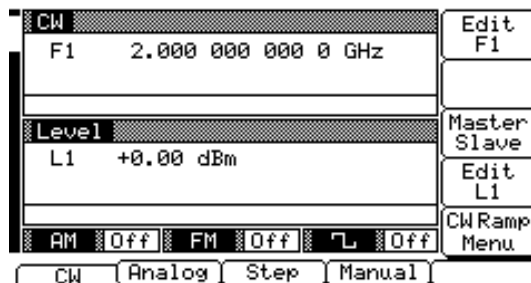

- b. Press **Edit F1** to open the current frequency parameter for editing.
- c. Set F1 to the CW frequency noted on the test record for the model being tested.
- d. Press **Edit L1** to open the current power level parameter for editing.
- e. Set L1 to the power level noted on the test record.

Step 2 Measure the output power level with the Power Meter and record the reading on the test record.

Step 3 Verify that the Power Meter reading meets the specifications stated on the test record.

Step 4 Set L1 to the next test power level. Record the Power Meter reading on the test record.

Step 5 Repeat step 4 for the other levels listed on the test record for the current CW frequency.

Step 6 Repeat steps 1 thru 5 for all CW frequencies listed on the test record.

**Power Level
Flatness Test
Procedure**

Power level flatness is checked by measuring the power level variation during a full band sweep; first in the step sweep mode, then in the analog sweep mode.

- Step 1** Set up the 681XXB as follows for a step sweep power level flatness test:
- a. Reset the instrument by pressing **SYSTEM**, then **Reset**. The CW Menu is displayed.
 - b. Press **Step** to place the 681XXB in the step sweep frequency mode and display the Step Sweep Menu.

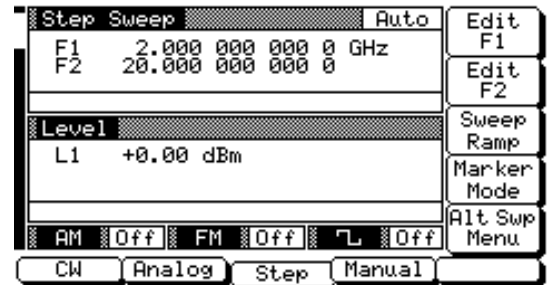

- c. With the Step Sweep menu displayed, press the main menu key

**FREQUENCY
CONTROL**

The Sweep Frequency Control menu, shown below, is displayed.

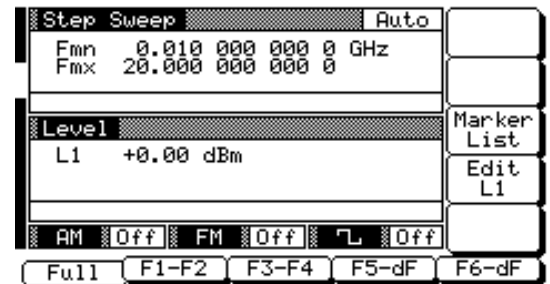

- d. Press **Full** to select a full range frequency sweep.
- e. Press **Edit L1** to open the current power level parameter for editing.
- f. Set L1 to the power level noted on the test record.

- g. Now, return to the Step Sweep menu by pressing the main menu key

**CW/SWEEP
SELECT**

- h. At the Step Sweep menu, press **Sweep Ramp** to go to the Step Sweep Ramp menu.

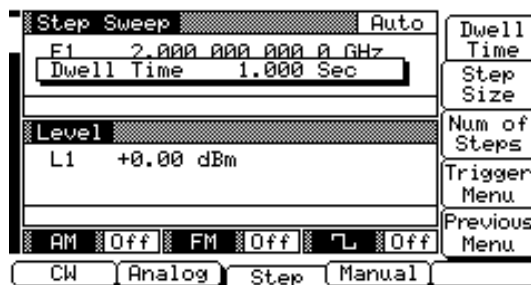

- i. Press **Dwell Time** to open the dwell time-per-step parameter for editing.
- j. Set the dwell time to 1 second.

NOTE

Monitor the 681XXB's Horizontal Output on the Oscilloscope to determine sweep start and stop.

- Step 2** As the 681XXB steps through the full frequency range, measure the maximum and minimum Power Meter readings and record the values on the test record. Verify that the variation (difference between the maximum and minimum readings) does not exceed the value noted on the test record.

- Step 3** Set up the 681XXB as follows for an analog sweep power level flatness test:
- Reset the instrument by pressing **SYSTEM**, then **Reset**. The CW Menu is displayed.
 - Press **Analog** to place the 681XXB in the analog sweep frequency mode and display the Analog Sweep Menu.

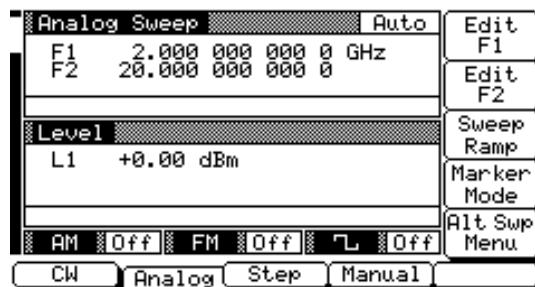

- With the Analog Sweep menu displayed, press the main menu key

**FREQUENCY
CONTROL**

The Sweep Frequency Control menu, shown below, is displayed.

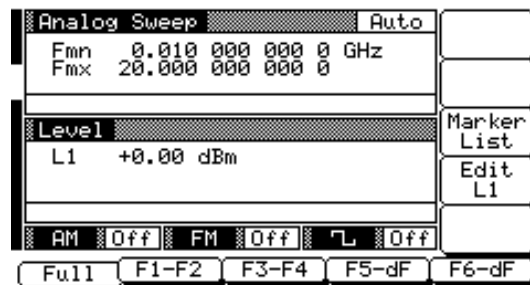

- Press **Full** to select a full range frequency sweep.
- Press **Edit L1** to open the current power level parameter for editing.
- Set L1 to the power level noted on the test record.
- Now, return to the Analog Sweep menu by pressing the main menu key

**CW/SWEEP
SELECT**

- h.** At the Analog Sweep menu, press the menu soft-key **Sweep Ramp** to go to the Analog Sweep Ramp menu.



- i.** Press **Sweep Time** to open the sweep time parameter for editing.
- j.** Set the sweep time to 99 seconds.

NOTE

Monitor the 681XXB's Horizontal Output on the Oscilloscope to determine sweep start and stop.

- Step 4** During the analog sweep, measure the maximum and minimum Power Meter readings and record the values on the test record. Verify that the variation (difference between the maximum and minimum readings) does not exceed the value noted on the test record.

Table 5-3. Power Level Accuracy and Flatness Test Record (1 of 24)

| Model 68137B | Serial No. _____ | Date _____ | |
|--|-----------------------|------------------|----------------------|
| Model 68137B (without Option 2A Step Attenuator) | | | |
| Power Level Accuracy * (CW Frequency = 5.0 GHz) | | | |
| Set Power | Measured Power | | |
| +13 dBm | _____dBm | | |
| +12 dBm | _____dBm | | |
| +11 dBm | _____dBm | | |
| +10 dBm | _____dBm | | |
| + 9 dBm | _____dBm | | |
| + 8 dBm | _____dBm | | |
| + 7 dBm | _____dBm | | |
| + 6 dBm | _____dBm | | |
| + 5 dBm | _____dBm | | |
| + 4 dBm | _____dBm | | |
| + 3 dBm | _____dBm | | |
| + 2 dBm | _____dBm | | |
| + 1 dBm | _____dBm | | |
| * Specification is ± 1.0 dB. | | | |
| Power Level Flatness (Step Sweep) | | | |
| Set Power | Max Power | Min Power | Variation ** |
| +13 dBm | _____dBm | _____dBm | _____dB |
| ** Maximum variation is 1.6 dB. | | | |
| Power Level Flatness (Analog Sweep) | | | |
| Set Power | Max Power | Min Power | Variation *** |
| +13 dBm | _____dBm | _____dBm | _____dB |
| *** Maximum variation is 2.0 dB (typical, not a specification). | | | |

Table 5-3. Power Level Accuracy and Flatness Test Record (2 of 24)

| | | |
|---------------------|-------------------------|-------------------|
| Model 68137B | Serial No. _____ | Date _____ |
|---------------------|-------------------------|-------------------|

**Model 68137B
(with Option 2A Step Attenuator)**

**Power Level Accuracy *
(CW Frequency = 5.0 GHz)**

| Set Power | Measured Power |
|-----------|----------------|
| +11 dBm | _____dBm |
| +10 dBm | _____dBm |
| + 9 dBm | _____dBm |
| + 8 dBm | _____dBm |
| + 7 dBm | _____dBm |
| + 6 dBm | _____dBm |
| + 5 dBm | _____dBm |
| + 4 dBm | _____dBm |
| + 3 dBm | _____dBm |
| + 2 dBm | _____dBm |
| + 1 dBm | _____dBm |
| + 0 dBm | _____dBm |
| - 1 dBm | _____dBm |

* Specification is ± 1.0 dB.

Power Level Flatness (Step Sweep)

| Set Power | Max Power | Min Power | Variation ** |
|-----------|-----------|-----------|--------------|
| +11 dBm | _____dBm | _____dBm | _____dB |

** Maximum variation is 1.6 dB.

Power Level Flatness (Analog Sweep)

| Set Power | Max Power | Min Power | Variation *** |
|-----------|-----------|-----------|---------------|
| +11 dBm | _____dBm | _____dBm | _____dB |

*** Maximum variation is 2.0 dB (typical, not a specification).

Table 5-3. Power Level Accuracy and Flatness Test Record (3 of 24)

| | | | |
|---|-------------------------|-------------------|----------------------|
| Model 68137B w/Option 15 | Serial No. _____ | Date _____ | |
| Model 68137B with Option 15 High Power (without Option 2A Step Attenuator) | | | |
| Power Level Accuracy * (CW Frequency = 5.0 GHz) | | | |
| Set Power | Measured Power | | |
| +17 dBm | _____dBm | | |
| +16 dBm | _____dBm | | |
| +15 dBm | _____dBm | | |
| +14 dBm | _____dBm | | |
| +13 dBm | _____dBm | | |
| +12 dBm | _____dBm | | |
| +11 dBm | _____dBm | | |
| +10 dBm | _____dBm | | |
| + 9 dBm | _____dBm | | |
| + 8 dBm | _____dBm | | |
| + 7 dBm | _____dBm | | |
| + 6 dBm | _____dBm | | |
| + 5 dBm | _____dBm | | |
| * Specification is ± 1.0 dB. | | | |
| Power Level Flatness (Step Sweep) | | | |
| Set Power | Max Power | Min Power | Variation ** |
| +17 dBm | _____dBm | _____dBm | _____dB |
| ** Maximum variation is 1.6 dB. | | | |
| Power Level Flatness (Analog Sweep) | | | |
| Set Power | Max Power | Min Power | Variation *** |
| +17 dBm | _____dBm | _____dBm | _____dB |
| *** Maximum variation is 2.0 dB (typical, not a specification). | | | |

Table 5-3. Power Level Accuracy and Flatness Test Record (4 of 24)

| | | |
|---------------------------------|-------------------------|-------------------|
| Model 68137B w/Option 15 | Serial No. _____ | Date _____ |
|---------------------------------|-------------------------|-------------------|

**Model 68137B with Option 15 High Power
(with Option 2A Step Attenuator)**

**Power Level Accuracy *
(CW Frequency = 5.0 GHz)**

| Set Power | Measured Power |
|-----------|----------------|
| +15 dBm | _____dBm |
| +14 dBm | _____dBm |
| +13 dBm | _____dBm |
| +12 dBm | _____dBm |
| +11 dBm | _____dBm |
| +10 dBm | _____dBm |
| + 9 dBm | _____dBm |
| + 8 dBm | _____dBm |
| + 7 dBm | _____dBm |
| + 6 dBm | _____dBm |
| + 5 dBm | _____dBm |
| + 4 dBm | _____dBm |
| + 3 dBm | _____dBm |

* Specification is ± 1.0 dB.

Power Level Flatness (Step Sweep)

| Set Power | Max Power | Min Power | Variation ** |
|-----------|-----------|-----------|--------------|
| +15 dBm | _____dBm | _____dBm | _____dB |

** Maximum variation is 1.6 dB.

Power Level Flatness (Analog Sweep)

| Set Power | Max Power | Min Power | Variation *** |
|-----------|-----------|-----------|---------------|
| +15 dBm | _____dBm | _____dBm | _____dB |

*** Maximum variation is 2.0 dB (typical, not a specification).

Table 5-3. Power Level Accuracy and Flatness Test Record (5 of 24)

| Model 68147B | | Serial No. _____ | | Date _____ | |
|---|-----------------------|------------------|--|------------|--|
| Model 68147B (without Option 2A Step Attenuator) | | | | | |
| Power Level Accuracy * (CW Frequency = 1.0 GHz) | | | Power Level Accuracy * (CW Frequency = 5.0 GHz) | | |
| Set Power | Measured Power | Set Power | Measured Power | | |
| +13 dBm | _____dBm | +13 dBm | _____dBm | | |
| +12 dBm | _____dBm | +12 dBm | _____dBm | | |
| +11 dBm | _____dBm | +11 dBm | _____dBm | | |
| +10 dBm | _____dBm | +10 dBm | _____dBm | | |
| + 9 dBm | _____dBm | + 9 dBm | _____dBm | | |
| + 8 dBm | _____dBm | + 8 dBm | _____dBm | | |
| + 7 dBm | _____dBm | + 7 dBm | _____dBm | | |
| + 6 dBm | _____dBm | + 6 dBm | _____dBm | | |
| + 5 dBm | _____dBm | + 5 dBm | _____dBm | | |
| + 4 dBm | _____dBm | + 4 dBm | _____dBm | | |
| + 3 dBm | _____dBm | + 3 dBm | _____dBm | | |
| + 2 dBm | _____dBm | + 2 dBm | _____dBm | | |
| + 1 dBm | _____dBm | + 1 dBm | _____dBm | | |
| * Specification is ± 1.0 dB. | | | * Specification is ± 1.0 dB. | | |
| Power Level Flatness (Step Sweep) | | | | | |
| Set Power | Max Power | Min Power | Variation ** | | |
| +13 dBm | _____dBm | _____dBm | _____dB | | |
| ** Maximum variation is 1.6 dB. | | | | | |
| Power Level Flatness (Analog Sweep) | | | | | |
| Set Power | Max Power | Min Power | Variation *** | | |
| +13 dBm | _____dBm | _____dBm | _____dB | | |
| *** Maximum variation is 2.0 dB (typical, not a specification). | | | | | |

OPERATION VERIFICATION

POWER LEVEL ACCURACY AND FLATNESS TESTS

Table 5-3. Power Level Accuracy and Flatness Test Record (6 of 24)

| | | |
|---------------------|-------------------------|-------------------|
| Model 68147B | Serial No. _____ | Date _____ |
|---------------------|-------------------------|-------------------|

**Model 68147B
(with Option 2A Step Attenuator)**

| Power Level Accuracy * (CW Frequency = 1.0 GHz) | | Power Level Accuracy * (CW Frequency = 5.0 GHz) | |
|--|----------------|--|----------------|
| Set Power | Measured Power | Set Power | Measured Power |
| +11 dBm | _____dBm | +11 dBm | _____dBm |
| +10 dBm | _____dBm | +10 dBm | _____dBm |
| + 9 dBm | _____dBm | + 9 dBm | _____dBm |
| + 8 dBm | _____dBm | + 8 dBm | _____dBm |
| + 7 dBm | _____dBm | + 7 dBm | _____dBm |
| + 6 dBm | _____dBm | + 6 dBm | _____dBm |
| + 5 dBm | _____dBm | + 5 dBm | _____dBm |
| + 4 dBm | _____dBm | + 4 dBm | _____dBm |
| + 3 dBm | _____dBm | + 3 dBm | _____dBm |
| + 2 dBm | _____dBm | + 2 dBm | _____dBm |
| + 1 dBm | _____dBm | + 1 dBm | _____dBm |
| + 0 dBm | _____dBm | + 0 dBm | _____dBm |
| - 1 dBm | _____dBm | - 1 dBm | _____dBm |

* Specification is ± 1.0 dB.

* Specification is ± 1.0 dB.

Power Level Flatness (Step Sweep)

| Set Power | Max Power | Min Power | Variation ** |
|-----------|-----------|-----------|--------------|
| +11 dBm | _____dBm | _____dBm | _____dB |

** Maximum variation is 1.6 dB.

Power Level Flatness (Analog Sweep)

| Set Power | Max Power | Min Power | Variation *** |
|-----------|-----------|-----------|---------------|
| +11 dBm | _____dBm | _____dBm | _____dB |

*** Maximum variation is 2.0 dB (typical, not a specification).

Table 5-3. Power Level Accuracy and Flatness Test Record (7 of 24)

| Model 68147B w/Option 15 | | Serial No. _____ | | Date _____ | |
|---|-----------------------|------------------|--|------------|--|
| Model 68147B with Option 15 High Power (without Option 2A Step Attenuator) | | | | | |
| Power Level Accuracy * (CW Frequency = 1.0 GHz) | | | Power Level Accuracy * (CW Frequency = 5.0 GHz) | | |
| Set Power | Measured Power | Set Power | Measured Power | | |
| +13 dBm | _____dBm | +17 dBm | _____dBm | | |
| +12 dBm | _____dBm | +16 dBm | _____dBm | | |
| +11 dBm | _____dBm | +15 dBm | _____dBm | | |
| +10 dBm | _____dBm | +14 dBm | _____dBm | | |
| + 9 dBm | _____dBm | +13 dBm | _____dBm | | |
| + 8 dBm | _____dBm | + 12dBm | _____dBm | | |
| + 7 dBm | _____dBm | +11 dBm | _____dBm | | |
| + 6 dBm | _____dBm | +10 dBm | _____dBm | | |
| + 5 dBm | _____dBm | + 9 dBm | _____dBm | | |
| + 4 dBm | _____dBm | + 8 dBm | _____dBm | | |
| + 3 dBm | _____dBm | + 7dBm | _____dBm | | |
| + 2 dBm | _____dBm | + 6 dBm | _____dBm | | |
| + 1 dBm | _____dBm | + 5 dBm | _____dBm | | |
| * Specification is ± 1.0 dB. | | | * Specification is ± 1.0 dB. | | |
| Power Level Flatness (Step Sweep) | | | | | |
| Set Power | Max Power | Min Power | Variation ** | | |
| +17 dBm | _____dBm | _____dBm | _____dB | | |
| ** Maximum variation is 1.6 dB. | | | | | |
| Power Level Flatness (Analog Sweep) | | | | | |
| Set Power | Max Power | Min Power | Variation *** | | |
| +17 dBm | _____dBm | _____dBm | _____dB | | |
| *** Maximum variation is 2.0 dB (typical, not a specification). | | | | | |

OPERATION VERIFICATION

POWER LEVEL ACCURACY AND FLATNESS TESTS

Table 5-3. Power Level Accuracy and Flatness Test Record (8 of 24)

| Model 68147B w/Option 15 | | Serial No. _____ | | Date _____ | |
|--|-----------------------|------------------|--|------------|--|
| Model 68147B with Option 15 High Power (with Option 2A Step Attenuator) | | | | | |
| Power Level Accuracy * (CW Frequency = 1.0 GHz) | | | Power Level Accuracy * (CW Frequency = 5.0 GHz) | | |
| Set Power | Measured Power | Set Power | Measured Power | | |
| +11 dBm | _____dBm | +15 dBm | _____dBm | | |
| +10 dBm | _____dBm | +14 dBm | _____dBm | | |
| + 9 dBm | _____dBm | +13 dBm | _____dBm | | |
| + 8 dBm | _____dBm | +12 dBm | _____dBm | | |
| + 7 dBm | _____dBm | +11 dBm | _____dBm | | |
| + 6 dBm | _____dBm | +10 dBm | _____dBm | | |
| + 5 dBm | _____dBm | + 9 dBm | _____dBm | | |
| + 4 dBm | _____dBm | + 8 dBm | _____dBm | | |
| + 3 dBm | _____dBm | + 7 dBm | _____dBm | | |
| + 2 dBm | _____dBm | + 6 dBm | _____dBm | | |
| + 1 dBm | _____dBm | + 5 dBm | _____dBm | | |
| + 0 dBm | _____dBm | + 4 dBm | _____dBm | | |
| - 1 dBm | _____dBm | + 3 dBm | _____dBm | | |
| * Specification is ± 1.0 dB. | | | * Specification is ± 1.0 dB. | | |
| Power Level Flatness (Step Sweep) | | | | | |
| Set Power | Max Power | Min Power | Variation ** | | |
| +15 dBm | _____dBm | _____dBm | _____dB | | |
| ** Maximum variation is 1.6 dB. | | | | | |
| Power Level Flatness (Analog Sweep) | | | | | |
| Set Power | Max Power | Min Power | Variation *** | | |
| +15 dBm | _____dBm | _____dBm | _____dB | | |
| *** Maximum variation is 2.0 dB (typical, not a specification). | | | | | |

OPERATION VERIFICATION

POWER LEVEL ACCURACY AND FLATNESS TESTS

Table 5-3. Power Level Accuracy and Flatness Test Record (9 of 24)

| Model 68153B | Serial No. _____ | Date _____ | |
|---|-----------------------|---|----------------------|
| Model 68153B (without Option 2A Step Attenuator) | | | |
| Power Level Accuracy * (CW Frequency = 5.0 GHz) | | Power Level Accuracy * (CW Frequency = 22.0 GHz) | |
| Set Power | Measured Power | Set Power | |
| Measured Power | | Measured Power | |
| + 9 dBm | _____dBm | + 6 dBm | |
| + 8 dBm | _____dBm | + 5 dBm | |
| + 7 dBm | _____dBm | + 4 dBm | |
| + 6 dBm | _____dBm | + 3 dBm | |
| + 5 dBm | _____dBm | + 2 dBm | |
| + 4 dBm | _____dBm | + 1 dBm | |
| + 3 dBm | _____dBm | + 0 dBm | |
| + 2 dBm | _____dBm | - 1 dBm | |
| + 1 dBm | _____dBm | - 2 dBm | |
| + 0 dBm | _____dBm | - 3 dBm | |
| - 1 dBm | _____dBm | - 4 dBm | |
| - 2 dBm | _____dBm | - 5 dBm | |
| - 3 dBm | _____dBm | - 6 dBm | |
| * Specification is ± 1.0 dB. | | * Specification is ± 1.0 dB. | |
| Power Level Flatness (Step Sweep) | | | |
| Set Power | Max Power | Min Power | Variation ** |
| + 6 dBm | _____dBm | _____dBm | _____dB |
| ** Maximum variation is 1.6 dB. | | | |
| Power Level Flatness (Analog Sweep) | | | |
| Set Power | Max Power | Min Power | Variation *** |
| + 6 dBm | _____dBm | _____dBm | _____dB |
| *** Maximum variation is 2.0 dB (2 to 20 GHz); 4.0 dB (20 to 26.5 GHz)(typical, not a specification). | | | |

OPERATION VERIFICATION

POWER LEVEL ACCURACY AND FLATNESS TESTS

Table 5-3. Power Level Accuracy and Flatness Test Record (10 of 24)

| | | | | | |
|---|-----------------------|-------------------------|---|-------------------|--|
| Model 68153B | | Serial No. _____ | | Date _____ | |
| Model 68153B (with Option 2A Step Attenuator) | | | | | |
| Power Level Accuracy * (CW Frequency = 5.0 GHz) | | | Power Level Accuracy * (CW Frequency = 22.0 GHz) | | |
| Set Power | Measured Power | Set Power | Measured Power | | |
| + 7 dBm | _____ dBm | + 3.5 dBm | _____ dBm | | |
| + 6 dBm | _____ dBm | + 2.5 dBm | _____ dBm | | |
| + 5 dBm | _____ dBm | + 1.5 dBm | _____ dBm | | |
| + 4 dBm | _____ dBm | + 0.5 dBm | _____ dBm | | |
| + 3 dBm | _____ dBm | - 0.5 dBm | _____ dBm | | |
| + 2 dBm | _____ dBm | - 1.5 dBm | _____ dBm | | |
| + 1 dBm | _____ dBm | - 2.5 dBm | _____ dBm | | |
| + 0 dBm | _____ dBm | - 3.5 dBm | _____ dBm | | |
| - 1 dBm | _____ dBm | - 4.5 dBm | _____ dBm | | |
| - 2 dBm | _____ dBm | - 5.5 dBm | _____ dBm | | |
| - 3 dBm | _____ dBm | - 6.5 dBm | _____ dBm | | |
| - 4 dBm | _____ dBm | - 7.5 dBm | _____ dBm | | |
| - 5 dBm | _____ dBm | - 8.5 dBm | _____ dBm | | |
| * Specification is ± 1.0 dB. | | | * Specification is ± 1.0 dB. | | |
| Power Level Flatness (Step Sweep) | | | | | |
| Set Power | Max Power | Min Power | Variation ** | | |
| + 3.5 dBm | _____ dBm | _____ dBm | _____ dB | | |
| ** Maximum variation is 1.6 dB. | | | | | |
| Power Level Flatness (Analog Sweep) | | | | | |
| Set Power | Max Power | Min Power | Variation *** | | |
| + 3.5 dBm | _____ dBm | _____ dBm | _____ dB | | |
| *** Maximum variation is 2.0 dB (2 to 20 GHz); 4.0 dB (20 to 26.5 GHz)(typical, not a specification). | | | | | |

OPERATION VERIFICATION

POWER LEVEL ACCURACY AND FLATNESS TESTS

Table 5-3. Power Level Accuracy and Flatness Test Record (11 of 24)

| Model 68153B w/Option 15 | Serial No. _____ | Date _____ | |
|---|-----------------------|---|----------------------|
| Model 68153B with Option 15 High Power (without Option 2A Step Attenuator) | | | |
| Power Level Accuracy * (CW Frequency = 5.0 GHz) | | Power Level Accuracy * (CW Frequency = 22.0 GHz) | |
| Set Power | Measured Power | Set Power | |
| Measured Power | | Measured Power | |
| +13 dBm | _____dBm | +10 dBm | _____dBm |
| +12 dBm | _____dBm | + 9 dBm | _____dBm |
| +11 dBm | _____dBm | + 8 dBm | _____dBm |
| +10 dBm | _____dBm | + 7 dBm | _____dBm |
| + 9 dBm | _____dBm | + 6 dBm | _____dBm |
| + 8 dBm | _____dBm | + 5 dBm | _____dBm |
| + 7 dBm | _____dBm | + 4 dBm | _____dBm |
| + 6 dBm | _____dBm | + 3 dBm | _____dBm |
| + 5 dBm | _____dBm | + 2 dBm | _____dBm |
| + 4 dBm | _____dBm | + 1 dBm | _____dBm |
| + 3 dBm | _____dBm | + 0 dBm | _____dBm |
| + 2 dBm | _____dBm | - 1 dBm | _____dBm |
| + 1 dBm | _____dBm | - 2 dBm | _____dBm |
| * Specification is ± 1.0 dB. | | * Specification is ± 1.0 dB. | |
| Power Level Flatness (Step Sweep) | | | |
| Set Power | Max Power | Min Power | Variation ** |
| + 10 dBm | _____dBm | _____dBm | _____dB |
| ** Maximum variation is 1.6 dB. | | | |
| Power Level Flatness (Analog Sweep) | | | |
| Set Power | Max Power | Min Power | Variation *** |
| + 10 dBm | _____dBm | _____dBm | _____dB |
| *** Maximum variation is 2.0 dB (2 to 20 GHz); 4.0 dB (20 to 26.5 GHz)(typical, not a specification). | | | |

Table 5-3. Power Level Accuracy and Flatness Test Record (12 of 24)

| Model 68153B w/Option 15 | Serial No. _____ | Date _____ | |
|---|-----------------------|---|-----------------------|
| Model 68153B with Option 15 High Power (with Option 2A Step Attenuator) | | | |
| Power Level Accuracy * (CW Frequency = 5.0 GHz) | | Power Level Accuracy * (CW Frequency = 22.0 GHz) | |
| Set Power | Measured Power | Set Power | Measured Power |
| +11 dBm | _____dBm | + 7.5 dBm | _____dBm |
| +10 dBm | _____dBm | + 6.5 dBm | _____dBm |
| + 9 dBm | _____dBm | + 5.5 dBm | _____dBm |
| + 8 dBm | _____dBm | + 4.5 dBm | _____dBm |
| + 7 dBm | _____dBm | + 3.5 dBm | _____dBm |
| + 6 dBm | _____dBm | + 2.5 dBm | _____dBm |
| + 5 dBm | _____dBm | + 1.5 dBm | _____dBm |
| + 4 dBm | _____dBm | + 0.5 dBm | _____dBm |
| + 3 dBm | _____dBm | - 0.5 dBm | _____dBm |
| + 2 dBm | _____dBm | - 1.5 dBm | _____dBm |
| + 1 dBm | _____dBm | - 2.5 dBm | _____dBm |
| + 0 dBm | _____dBm | - 3.5 dBm | _____dBm |
| - 1 dBm | _____dBm | - 4.5 dBm | _____dBm |
| * Specification is ± 1.0 dB. | | * Specification is ± 1.0 dB. | |
| Power Level Flatness (Step Sweep) | | | |
| Set Power | Max Power | Min Power | Variation ** |
| + 7.5 dBm | _____dBm | _____dBm | _____dB |
| ** Maximum variation is 1.6 dB. | | | |
| Power Level Flatness (Analog Sweep) | | | |
| Set Power | Max Power | Min Power | Variation *** |
| + 7.5 dBm | _____dBm | _____dBm | _____dB |
| *** Maximum variation is 2.0 dB (2 to 20 GHz); 4.0 dB (20 to 26.5 GHz)(typical, not a specification). | | | |

OPERATION VERIFICATION

POWER LEVEL ACCURACY AND FLATNESS TESTS

Table 5-3. Power Level Accuracy and Flatness Test Record (13 of 24)

| Model 68159B | | Serial No. _____ | | Date _____ | |
|---|-----------------------|---|-----------------------|--|-----------------------|
| Model 68159B (without Option 2A Step Attenuator) | | | | | |
| Power Level Accuracy * (CW Frequency = 1.0 GHz) | | Power Level Accuracy * (CW Frequency = 5.0 GHz) | | Power Level Accuracy * (CW Frequency = 22.0 GHz) | |
| Set Power | Measured Power | Set Power | Measured Power | Set Power | Measured Power |
| +13 dBm | _____dBm | + 9 dBm | _____dBm | + 6 dBm | _____dBm |
| +12 dBm | _____dBm | + 8 dBm | _____dBm | + 5 dBm | _____dBm |
| +11 dBm | _____dBm | + 7 dBm | _____dBm | + 4 dBm | _____dBm |
| +10 dBm | _____dBm | + 6 dBm | _____dBm | + 3 dBm | _____dBm |
| + 9 dBm | _____dBm | + 5 dBm | _____dBm | + 2 dBm | _____dBm |
| + 8 dBm | _____dBm | + 4 dBm | _____dBm | + 1 dBm | _____dBm |
| + 7 dBm | _____dBm | + 3 dBm | _____dBm | + 0 dBm | _____dBm |
| + 6 dBm | _____dBm | + 2 dBm | _____dBm | - 1 dBm | _____dBm |
| + 5 dBm | _____dBm | + 1 dBm | _____dBm | - 2 dBm | _____dBm |
| + 4 dBm | _____dBm | + 0 dBm | _____dBm | - 3 dBm | _____dBm |
| + 3 dBm | _____dBm | - 1 dBm | _____dBm | - 4 dBm | _____dBm |
| + 2 dBm | _____dBm | - 2 dBm | _____dBm | - 5 dBm | _____dBm |
| + 1 dBm | _____dBm | - 3 dBm | _____dBm | - 6 dBm | _____dBm |
| * Specification is ± 1.0 dB. | | * Specification is ± 1.0 dB. | | * Specification is ± 1.0 dB. | |
| Power Level Flatness (Step Sweep) | | | | | |
| Set Power | Max Power | Min Power | Variation ** | | |
| + 6 dBm | _____dBm | _____dBm | _____dB | | |
| ** Maximum variation is 1.6 dB. | | | | | |
| Power Level Flatness (Analog Sweep) | | | | | |
| Set Power | Max Power | Min Power | Variation *** | | |
| + 6 dBm | _____dBm | _____dBm | _____dB | | |
| *** Maximum variation is 2.0 dB (2 to 20 GHz); 4.0 dB (20 to 26.5 GHz)(typical, not a specification). | | | | | |

OPERATION VERIFICATION

POWER LEVEL ACCURACY AND FLATNESS TESTS

Table 5-3. Power Level Accuracy and Flatness Test Record (14 of 24)

| Model 68159B | | Serial No. _____ | | Date _____ | |
|---|-----------------------|---|-----------------------|--|-----------------------|
| Model 68159B (with Option 2A Step Attenuator) | | | | | |
| Power Level Accuracy * (CW Frequency = 1.0 GHz) | | Power Level Accuracy * (CW Frequency = 5.0 GHz) | | Power Level Accuracy * (CW Frequency = 22.0 GHz) | |
| Set Power | Measured Power | Set Power | Measured Power | Set Power | Measured Power |
| +11 dBm | _____dBm | + 7 dBm | _____dBm | + 3.5 dBm | _____dBm |
| +10 dBm | _____dBm | + 6 dBm | _____dBm | + 2.5 dBm | _____dBm |
| + 9 dBm | _____dBm | + 5 dBm | _____dBm | + 1.5 dBm | _____dBm |
| + 8 dBm | _____dBm | + 4 dBm | _____dBm | + 0.5 dBm | _____dBm |
| + 7 dBm | _____dBm | + 3 dBm | _____dBm | - 0.5 dBm | _____dBm |
| + 6 dBm | _____dBm | + 2 dBm | _____dBm | - 1.5 dBm | _____dBm |
| + 5 dBm | _____dBm | + 1 dBm | _____dBm | - 2.5 dBm | _____dBm |
| + 4 dBm | _____dBm | + 0 dBm | _____dBm | - 3.5 dBm | _____dBm |
| + 3 dBm | _____dBm | - 1 dBm | _____dBm | - 4.5 dBm | _____dBm |
| + 2 dBm | _____dBm | - 2 dBm | _____dBm | - 5.5 dBm | _____dBm |
| + 1 dBm | _____dBm | - 3 dBm | _____dBm | - 6.5 dBm | _____dBm |
| + 0 dBm | _____dBm | - 4 dBm | _____dBm | - 7.5 dBm | _____dBm |
| - 1 dBm | _____dBm | - 5 dBm | _____dBm | - 8.5 dBm | _____dBm |
| * Specification is ± 1.0 dB. | | * Specification is ± 1.0 dB. | | * Specification is ± 1.0 dB. | |
| Power Level Flatness (Step Sweep) | | | | | |
| Set Power | Max Power | Min Power | Variation ** | | |
| + 3.5 dBm | _____dBm | _____dBm | _____dB | | |
| ** Maximum variation is 1.6 dB. | | | | | |
| Power Level Flatness (Analog Sweep) | | | | | |
| Set Power | Max Power | Min Power | Variation *** | | |
| + 3.5 dBm | _____dBm | _____dBm | _____dB | | |
| *** Maximum variation is 2.0 dB (2 to 20 GHz); 4.0 dB (20 to 26.5 GHz)(typical, not a specification). | | | | | |

Table 5-3. Power Level Accuracy and Flatness Test Record (15 of 24)

| Model 68159B w/Option 15 | | Serial No. _____ | | Date _____ | |
|---|----------------|--|----------------|---|----------------|
| Model 68159B with Option 15 High Power (without Option 2A Step Attenuator) | | | | | |
| Power Level Accuracy * (CW Frequency = 1.0 GHz) | | Power Level Accuracy * (CW Frequency = 5.0 GHz) | | Power Level Accuracy * (CW Frequency = 22.0 GHz) | |
| Set Power | Measured Power | Set Power | Measured Power | Set Power | Measured Power |
| +13 dBm | _____dBm | +13 dBm | _____dBm | +10 dBm | _____dBm |
| +12 dBm | _____dBm | +12 dBm | _____dBm | + 9 dBm | _____dBm |
| +11 dBm | _____dBm | +11 dBm | _____dBm | + 8 dBm | _____dBm |
| +10 dBm | _____dBm | +10 dBm | _____dBm | + 7 dBm | _____dBm |
| + 9 dBm | _____dBm | + 9 dBm | _____dBm | + 6 dBm | _____dBm |
| + 8 dBm | _____dBm | + 8 dBm | _____dBm | + 5 dBm | _____dBm |
| + 7 dBm | _____dBm | + 7 dBm | _____dBm | + 4 dBm | _____dBm |
| + 6 dBm | _____dBm | + 6 dBm | _____dBm | + 3 dBm | _____dBm |
| + 5 dBm | _____dBm | + 5 dBm | _____dBm | + 2 dBm | _____dBm |
| + 4 dBm | _____dBm | + 4 dBm | _____dBm | + 1 dBm | _____dBm |
| + 3 dBm | _____dBm | + 3 dBm | _____dBm | + 0 dBm | _____dBm |
| + 2 dBm | _____dBm | + 2 dBm | _____dBm | - 1 dBm | _____dBm |
| + 1 dBm | _____dBm | + 1 dBm | _____dBm | - 2 dBm | _____dBm |
| * Specification is ±1.0 dB. | | * Specification is ±1.0 dB. | | * Specification is ±1.0 dB. | |
| Power Level Flatness (Step Sweep) | | | | | |
| Set Power | Max Power | Min Power | Variation ** | | |
| + 10 dBm | _____dBm | _____dBm | _____dB | | |
| ** Maximum variation is 1.6 dB. | | | | | |
| Power Level Flatness (Analog Sweep) | | | | | |
| Set Power | Max Power | Min Power | Variation *** | | |
| + 10 dBm | _____dBm | _____dBm | _____dB | | |
| *** Maximum variation is 2.0 dB (2 to 20 GHz); 4.0 dB (20 to 26.5 GHz)(typical, not a specification). | | | | | |

Table 5-3. Power Level Accuracy and Flatness Test Record (16 of 24)

Model 68159B w/Option 15 **Serial No.** _____ **Date** _____

**Model 68159B with Option 15 High Power
(with Option 2A Step Attenuator)**

| Power Level Accuracy * (CW Frequency = 1.0 GHz) | | Power Level Accuracy * (CW Frequency = 5.0 GHz) | | Power Level Accuracy * (CW Frequency = 22.0 GHz) | |
|--|----------------|--|----------------|---|----------------|
| Set Power | Measured Power | Set Power | Measured Power | Set Power | Measured Power |
| +11 dBm | _____dBm | +11 dBm | _____dBm | + 7.5 dBm | _____dBm |
| +10 dBm | _____dBm | +10 dBm | _____dBm | + 6.5 dBm | _____dBm |
| + 9 dBm | _____dBm | + 9 dBm | _____dBm | + 5.5 dBm | _____dBm |
| + 8 dBm | _____dBm | + 8 dBm | _____dBm | + 4.5 dBm | _____dBm |
| + 7 dBm | _____dBm | + 7 dBm | _____dBm | + 3.5 dBm | _____dBm |
| + 6 dBm | _____dBm | + 6 dBm | _____dBm | + 2.5 dBm | _____dBm |
| + 5 dBm | _____dBm | + 5 dBm | _____dBm | + 1.5 dBm | _____dBm |
| + 4 dBm | _____dBm | + 4 dBm | _____dBm | + 0.5 dBm | _____dBm |
| + 3 dBm | _____dBm | + 3 dBm | _____dBm | - 0.5 dBm | _____dBm |
| + 2 dBm | _____dBm | + 2 dBm | _____dBm | - 1.5 dBm | _____dBm |
| + 1 dBm | _____dBm | + 1 dBm | _____dBm | - 2.5 dBm | _____dBm |
| + 0 dBm | _____dBm | + 0 dBm | _____dBm | - 3.5 dBm | _____dBm |
| - 1 dBm | _____dBm | - 1 dBm | _____dBm | - 4.5 dBm | _____dBm |

* Specification is ± 1.0 dB.

* Specification is ± 1.0 dB.

* Specification is ± 1.0 dB.

Power Level Flatness (Step Sweep)

| Set Power | Max Power | Min Power | Variation ** |
|-----------|-----------|-----------|--------------|
| + 7.5 dBm | _____dBm | _____dBm | _____dB |

** Maximum variation is 1.6 dB.

Power Level Flatness (Analog Sweep)

| Set Power | Max Power | Min Power | Variation *** |
|-----------|-----------|-----------|---------------|
| + 7.5 dBm | _____dBm | _____dBm | _____dB |

*** Maximum variation is 2.0 dB (2 to 20 GHz); 4.0 dB (20 to 26.5 GHz)(typical, not a specification).

Table 5-3. Power Level Accuracy and Flatness Test Record (17 of 24)

| Model 68163B | Serial No. _____ | Date _____ | |
|---|-----------------------|---|----------------------|
| Model 68163B (without Option 2B Step Attenuator) | | | |
| Power Level Accuracy * (CW Frequency = 5.0 GHz) | | Power Level Accuracy * (CW Frequency = 25.0 GHz) | |
| Set Power | Measured Power | Set Power | |
| Measured Power | | Measured Power | |
| + 9 dBm | _____dBm | + 6 dBm | |
| + 8 dBm | _____dBm | + 5 dBm | |
| + 7 dBm | _____dBm | + 4 dBm | |
| + 6 dBm | _____dBm | + 3 dBm | |
| + 5 dBm | _____dBm | + 2dBm | |
| + 4 dBm | _____dBm | + 1 dBm | |
| + 3 dBm | _____dBm | + 0 dBm | |
| + 2 dBm | _____dBm | - 1 dBm | |
| + 1 dBm | _____dBm | - 2 dBm | |
| + 0 dBm | _____dBm | - 3 dBm | |
| - 1 dBm | _____dBm | - 4 dBm | |
| - 2 dBm | _____dBm | - 5 dBm | |
| - 3 dBm | _____dBm | - 6 dBm | |
| * Specification is ± 1.0 dB. | | * Specification is ± 1.0 dB. | |
| Power Level Flatness (Step Sweep) | | | |
| Set Power | Max Power | Min Power | Variation ** |
| + 6 dBm | _____dBm | _____dBm | _____dB |
| ** Maximum variation is 1.6 dB. | | | |
| Power Level Flatness (Analog Sweep) | | | |
| Set Power | Max Power | Min Power | Variation *** |
| + 6 dBm | _____dBm | _____dBm | _____dB |
| *** Maximum variation is 2.0 dB (2 to 20 GHz); 4.0 dB (20 to 40 GHz)(typical, not a specification). | | | |

Table 5-3. Power Level Accuracy and Flatness Test Record (18 of 24)

| | | |
|---------------------|-------------------------|-------------------|
| Model 68163B | Serial No. _____ | Date _____ |
|---------------------|-------------------------|-------------------|

**Model 68163B
(with Option 2B Step Attenuator)**

| Power Level Accuracy * (CW Frequency = 5.0 GHz) | | Power Level Accuracy * (CW Frequency = 25.0 GHz) | |
|---|-----------------------|--|-----------------------|
| Set Power | Measured Power | Set Power | Measured Power |
| + 7 dBm | _____ dBm | + 3 dBm | _____ dBm |
| + 6 dBm | _____ dBm | + 2 dBm | _____ dBm |
| + 5 dBm | _____ dBm | + 1 dBm | _____ dBm |
| + 4 dBm | _____ dBm | + 0 dBm | _____ dBm |
| + 3 dBm | _____ dBm | - 1 dBm | _____ dBm |
| + 2 dBm | _____ dBm | - 2 dBm | _____ dBm |
| + 1 dBm | _____ dBm | - 3 dBm | _____ dBm |
| + 0 dBm | _____ dBm | - 4 dBm | _____ dBm |
| - 1 dBm | _____ dBm | - 5 dBm | _____ dBm |
| - 2 dBm | _____ dBm | - 6 dBm | _____ dBm |
| - 3 dBm | _____ dBm | - 7 dBm | _____ dBm |
| - 4 dBm | _____ dBm | - 8 dBm | _____ dBm |
| - 5 dBm | _____ dBm | - 9 dBm | _____ dBm |

* Specification is ± 1.0 dB.

* Specification is ± 1.0 dB.

Power Level Flatness (Step Sweep)

| Set Power | Max Power | Min Power | Variation ** |
|------------------|------------------|------------------|---------------------|
| + 3 dBm | _____ dBm | _____ dBm | _____ dB |

** Maximum variation is 1.6 dB.

Power Level Flatness (Analog Sweep)

| Set Power | Max Power | Min Power | Variation *** |
|------------------|------------------|------------------|----------------------|
| + 3 dBm | _____ dBm | _____ dBm | _____ dB |

*** Maximum variation is 2.0 dB (2 to 20 GHz); 4.0 dB (20 to 40 GHz)(typical, not a specification).

OPERATION VERIFICATION

POWER LEVEL ACCURACY AND FLATNESS TESTS

Table 5-3. Power Level Accuracy and Flatness Test Record (19 of 24)

| Model 68163B w/Option 15 | Serial No. _____ | Date _____ | |
|---|-----------------------|---|----------------------|
| Model 68163B with Option 15 High Power (without Option 2B Step Attenuator) | | | |
| Power Level Accuracy * (CW Frequency = 5.0 GHz) | | Power Level Accuracy * (CW Frequency = 25.0 GHz) | |
| Set Power | Measured Power | Set Power | |
| Measured Power | | Measured Power | |
| +13 dBm | _____dBm | + 6 dBm | |
| +12 dBm | _____dBm | + 5 dBm | |
| +11 dBm | _____dBm | + 4 dBm | |
| +10 dBm | _____dBm | + 3 dBm | |
| + 9 dBm | _____dBm | + 2 dBm | |
| + 8 dBm | _____dBm | + 1 dBm | |
| + 7 dBm | _____dBm | + 0 dBm | |
| + 6 dBm | _____dBm | - 1 dBm | |
| + 5 dBm | _____dBm | - 2 dBm | |
| + 4 dBm | _____dBm | - 3 dBm | |
| + 3 dBm | _____dBm | - 4 dBm | |
| + 2 dBm | _____dBm | - 5 dBm | |
| + 1 dBm | _____dBm | - 6 dBm | |
| * Specification is ± 1.0 dB. | | * Specification is ± 1.0 dB. | |
| Power Level Flatness (Step Sweep) | | | |
| Set Power | Max Power | Min Power | Variation ** |
| + 6 dBm | _____dBm | _____dBm | _____dB |
| ** Maximum variation is 1.6 dB. | | | |
| Power Level Flatness (Analog Sweep) | | | |
| Set Power | Max Power | Min Power | Variation *** |
| + 6 dBm | _____dBm | _____dBm | _____dB |
| *** Maximum variation is 2.0 dB (2 to 20 GHz); 4.0 dB (20 to 40 GHz)(typical, not a specification). | | | |

Table 5-3. Power Level Accuracy and Flatness Test Record (20 of 24)

| Model 68163B w/Option 15 | Serial No. _____ | Date _____ | |
|---|-----------------------|---|-----------------------|
| Model 68163B with Option 15 High Power (with Option 2B Step Attenuator) | | | |
| Power Level Accuracy * (CW Frequency = 5.0 GHz) | | Power Level Accuracy * (CW Frequency = 25.0 GHz) | |
| Set Power | Measured Power | Set Power | Measured Power |
| +11 dBm | _____dBm | + 3 dBm | _____dBm |
| +10 dBm | _____dBm | + 2 dBm | _____dBm |
| + 9 dBm | _____dBm | + 1 dBm | _____dBm |
| + 8 dBm | _____dBm | + 0 dBm | _____dBm |
| + 7 dBm | _____dBm | - 1 dBm | _____dBm |
| + 6 dBm | _____dBm | - 2 dBm | _____dBm |
| + 5 dBm | _____dBm | - 3 dBm | _____dBm |
| + 4 dBm | _____dBm | - 4 dBm | _____dBm |
| + 3 dBm | _____dBm | - 5 dBm | _____dBm |
| + 2 dBm | _____dBm | - 6 dBm | _____dBm |
| + 1 dBm | _____dBm | - 7 dBm | _____dBm |
| + 0 dBm | _____dBm | - 8 dBm | _____dBm |
| - 1 dBm | _____dBm | - 9 dBm | _____dBm |
| * Specification is ± 1.0 dB. | | * Specification is ± 1.0 dB. | |
| Power Level Flatness (Step Sweep) | | | |
| Set Power | Max Power | Min Power | Variation ** |
| + 3 dBm | _____dBm | _____dBm | _____dB |
| ** Maximum variation is 1.6 dB. | | | |
| Power Level Flatness (Analog Sweep) | | | |
| Set Power | Max Power | Min Power | Variation *** |
| + 3 dBm | _____dBm | _____dBm | _____dB |
| *** Maximum variation is 2.0 dB (2 to 20 GHz); 4.0 dB (20 to 40 GHz)(typical, not a specification). | | | |

Table 5-3. Power Level Accuracy and Flatness Test Record (21 of 24)

| Model 68169B | | Serial No. _____ | | Date _____ | |
|---|----------------|--|----------------|---|----------------|
| Model 68169B (without Option 2B Step Attenuator) | | | | | |
| Power Level Accuracy * (CW Frequency = 1.0 GHz) | | Power Level Accuracy * (CW Frequency = 5.0 GHz) | | Power Level Accuracy * (CW Frequency = 25.0 GHz) | |
| Set Power | Measured Power | Set Power | Measured Power | Set Power | Measured Power |
| +13 dBm | _____dBm | + 9 dBm | _____dBm | + 6dBm | _____dBm |
| +12 dBm | _____dBm | + 8 dBm | _____dBm | + 5 dBm | _____dBm |
| +11 dBm | _____dBm | + 7 dBm | _____dBm | + 4 dBm | _____dBm |
| +10 dBm | _____dBm | + 6 dBm | _____dBm | + 3 dBm | _____dBm |
| + 9 dBm | _____dBm | + 5 dBm | _____dBm | + 2dBm | _____dBm |
| + 8 dBm | _____dBm | + 4 dBm | _____dBm | + 1 dBm | _____dBm |
| + 7 dBm | _____dBm | + 3 dBm | _____dBm | + 0 dBm | _____dBm |
| + 6 dBm | _____dBm | + 2 dBm | _____dBm | - 1 dBm | _____dBm |
| + 5 dBm | _____dBm | + 1 dBm | _____dBm | - 2 dBm | _____dBm |
| + 4 dBm | _____dBm | + 0 dBm | _____dBm | - 3 dBm | _____dBm |
| + 3 dBm | _____dBm | - 1 dBm | _____dBm | - 4 dBm | _____dBm |
| + 2 dBm | _____dBm | - 2 dBm | _____dBm | - 5 dBm | _____dBm |
| + 1 dBm | _____dBm | - 3 dBm | _____dBm | - 6 dBm | _____dBm |
| * Specification is ±1.0 dB. | | * Specification is ±1.0 dB. | | * Specification is ±1.0 dB. | |

Power Level Flatness (Step Sweep)

| Set Power | Max Power | Min Power | Variation ** |
|-----------|-----------|-----------|--------------|
| + 6 dBm | _____dBm | _____dBm | _____dB |

** Maximum variation is 1.6 dB.

Power Level Flatness (Analog Sweep)

| Set Power | Max Power | Min Power | Variation *** |
|-----------|-----------|-----------|---------------|
| + 6 dBm | _____dBm | _____dBm | _____dB |

*** Maximum variation is 2.0 dB (0.01 to 20 GHz); 4.0 dB (20 to 40 GHz)(typical, not a specification).

Table 5-3. Power Level Accuracy and Flatness Test Record (22 of 24)

| Model 68169B | | Serial No. _____ | | Date _____ | |
|--|----------------|--|----------------|---|----------------|
| Model 68169B (with Option 2B Step Attenuator) | | | | | |
| Power Level Accuracy * (CW Frequency = 1.0 GHz) | | Power Level Accuracy * (CW Frequency = 5.0 GHz) | | Power Level Accuracy * (CW Frequency = 25.0 GHz) | |
| Set Power | Measured Power | Set Power | Measured Power | Set Power | Measured Power |
| +11 dBm | _____dBm | + 7 dBm | _____dBm | + 3 dBm | _____dBm |
| +10 dBm | _____dBm | + 6 dBm | _____dBm | + 2 dBm | _____dBm |
| + 9 dBm | _____dBm | + 5 dBm | _____dBm | + 1 dBm | _____dBm |
| + 8 dBm | _____dBm | + 4 dBm | _____dBm | + 0 dBm | _____dBm |
| + 7 dBm | _____dBm | + 3 dBm | _____dBm | - 1 dBm | _____dBm |
| + 6 dBm | _____dBm | + 2 dBm | _____dBm | - 2 dBm | _____dBm |
| + 5 dBm | _____dBm | + 1 dBm | _____dBm | - 3 dBm | _____dBm |
| + 4 dBm | _____dBm | + 0 dBm | _____dBm | - 4 dBm | _____dBm |
| + 3 dBm | _____dBm | - 1 dBm | _____dBm | - 5 dBm | _____dBm |
| + 2 dBm | _____dBm | - 2 dBm | _____dBm | - 6 dBm | _____dBm |
| + 1 dBm | _____dBm | - 3 dBm | _____dBm | - 7 dBm | _____dBm |
| + 0 dBm | _____dBm | - 4 dBm | _____dBm | - 8 dBm | _____dBm |
| - 1 dBm | _____dBm | - 5 dBm | _____dBm | - 9 dBm | _____dBm |

* Specification is ± 1.0 dB.

* Specification is ± 1.0 dB.

* Specification is ± 1.0 dB.

Power Level Flatness (Step Sweep)

| Set Power | Max Power | Min Power | Variation ** |
|-----------|-----------|-----------|--------------|
| + 3 dBm | _____dBm | _____dBm | _____dB |

** Maximum variation is 1.6 dB.

Power Level Flatness (Analog Sweep)

| Set Power | Max Power | Min Power | Variation *** |
|-----------|-----------|-----------|---------------|
| + 3 dBm | _____dBm | _____dBm | _____dB |

*** Maximum variation is 2.0 dB (0.01 to 20 GHz); 4.0 dB (20 to 40 GHz)(typical, not a specification).

Table 5-3. Power Level Accuracy and Flatness Test Record (23 of 24)

| Model 68169B w/Option 15 | | Serial No. _____ | | Date _____ | |
|---|----------------|--|----------------|---|----------------|
| Model 68169B with Option 15 High Power (without Option 2B Step Attenuator) | | | | | |
| Power Level Accuracy * (CW Frequency = 1.0 GHz) | | Power Level Accuracy * (CW Frequency = 5.0 GHz) | | Power Level Accuracy * (CW Frequency = 25.0 GHz) | |
| Set Power | Measured Power | Set Power | Measured Power | Set Power | Measured Power |
| +13 dBm | _____dBm | +13 dBm | _____dBm | + 6 dBm | _____dBm |
| +12 dBm | _____dBm | +12 dBm | _____dBm | + 5 dBm | _____dBm |
| +11 dBm | _____dBm | +11 dBm | _____dBm | + 4 dBm | _____dBm |
| +10 dBm | _____dBm | +10 dBm | _____dBm | + 3 dBm | _____dBm |
| + 9 dBm | _____dBm | + 9 dBm | _____dBm | + 2 dBm | _____dBm |
| + 8 dBm | _____dBm | + 8 dBm | _____dBm | + 1 dBm | _____dBm |
| + 7 dBm | _____dBm | + 7 dBm | _____dBm | + 0 dBm | _____dBm |
| + 6 dBm | _____dBm | + 6 dBm | _____dBm | - 1 dBm | _____dBm |
| + 5 dBm | _____dBm | + 5 dBm | _____dBm | - 2 dBm | _____dBm |
| + 4 dBm | _____dBm | + 4 dBm | _____dBm | - 3 dBm | _____dBm |
| + 3 dBm | _____dBm | + 3 dBm | _____dBm | - 4 dBm | _____dBm |
| + 2 dBm | _____dBm | + 2 dBm | _____dBm | - 5 dBm | _____dBm |
| + 1 dBm | _____dBm | + 1 dBm | _____dBm | - 6 dBm | _____dBm |
| * Specification is ±1.0 dB. | | * Specification is ±1.0 dB. | | * Specification is ±1.0 dB. | |
| Power Level Flatness (Step Sweep) | | | | | |
| Set Power | Max Power | Min Power | Variation ** | | |
| + 6 dBm | _____dBm | _____dBm | _____dB | | |
| ** Maximum variation is 1.6 dB. | | | | | |
| Power Level Flatness (Analog Sweep) | | | | | |
| Set Power | Max Power | Min Power | Variation *** | | |
| + 6 dBm | _____dBm | _____dBm | _____dB | | |
| *** Maximum variation is 2.0 dB (2 to 20 GHz); 4.0 dB (20 to 40 GHz)(typical, not a specification). | | | | | |

Table 5-3. Power Level Accuracy and Flatness Test Record (24 of 24)

| Model 68169B w/Option 15 | | Serial No. _____ | | Date _____ | |
|---|----------------|--|----------------|---|----------------|
| Model 68169B with Option 15 High Power (with Option 2B Step Attenuator) | | | | | |
| Power Level Accuracy * (CW Frequency = 1.0 GHz) | | Power Level Accuracy * (CW Frequency = 5.0 GHz) | | Power Level Accuracy * (CW Frequency = 25.0 GHz) | |
| Set Power | Measured Power | Set Power | Measured Power | Set Power | Measured Power |
| +11 dBm | _____dBm | +11 dBm | _____dBm | + 3 dBm | _____dBm |
| +10 dBm | _____dBm | +10 dBm | _____dBm | + 2 dBm | _____dBm |
| + 9 dBm | _____dBm | + 9 dBm | _____dBm | + 1 dBm | _____dBm |
| + 8 dBm | _____dBm | + 8 dBm | _____dBm | + 0 dBm | _____dBm |
| + 7 dBm | _____dBm | + 7 dBm | _____dBm | - 1 dBm | _____dBm |
| + 6 dBm | _____dBm | + 6 dBm | _____dBm | - 2 dBm | _____dBm |
| + 5 dBm | _____dBm | + 5 dBm | _____dBm | - 3 dBm | _____dBm |
| + 4 dBm | _____dBm | + 4 dBm | _____dBm | - 4 dBm | _____dBm |
| + 3 dBm | _____dBm | + 3 dBm | _____dBm | - 5 dBm | _____dBm |
| + 2 dBm | _____dBm | + 2 dBm | _____dBm | - 6 dBm | _____dBm |
| + 1 dBm | _____dBm | + 1 dBm | _____dBm | - 7 dBm | _____dBm |
| + 0 dBm | _____dBm | + 0 dBm | _____dBm | - 8 dBm | _____dBm |
| - 1 dBm | _____dBm | - 1 dBm | _____dBm | - 9 dBm | _____dBm |
| * Specification is ± 1.0 dB. | | * Specification is ± 1.0 dB. | | * Specification is ± 1.0 dB. | |
| Power Level Flatness (Step Sweep) | | | | | |
| Set Power | Max Power | Min Power | Variation ** | | |
| + 3 dBm | _____dBm | _____dBm | _____dB | | |
| ** Maximum variation is 1.6 dB. | | | | | |
| Power Level Flatness (Analog Sweep) | | | | | |
| Set Power | Max Power | Min Power | Variation *** | | |
| + 3 dBm | _____dBm | _____dBm | _____dB | | |
| *** Maximum variation is 2.0 dB (2 to 20 GHz); 4.0 dB (20 to 40 GHz)(typical, not a specification). | | | | | |

Chapter 6

Operator Maintenance

Table of Contents

| | | |
|-----|---|------|
| 6-1 | INTRODUCTION | 6-3 |
| 6-2 | ERROR AND WARNING/STATUS MESSAGES . . | 6-3 |
| | Self-Test Error Messages | 6-3 |
| | Normal Operation Error and Warning/Status Messages | 6-8 |
| 6-3 | TROUBLESHOOTING | 6-10 |
| 6-4 | ROUTINE MAINTENANCE | 6-13 |
| | Replacing the Line Fuse | 6-13 |
| | Cleaning the Fan Filter | 6-14 |
| | Cleaning the Data Display | 6-14 |

Chapter 6

Operator Maintenance

6-1 INTRODUCTION

This chapter provides the information necessary for operator maintenance of the sweep generator. Operator maintenance is limited to troubleshooting and repairs that can be made without removing the instrument covers.

6-2 ERROR AND WARNING/STATUS MESSAGES

During normal operation, the 681XXB generates error messages to indicate internal malfunctions, abnormal signal generator operations, or invalid signal inputs or data entries. It also displays warning messages to alert the operator to conditions that could result in inaccurate sweep generator output. In addition, status messages are displayed to remind the operator of current menu selections or settings.

Self-Test Error Messages

The 681XXB firmware includes internal diagnostics that self-test the instrument. These self-test diagnostics perform a brief go/no-go test of most of the instrument PCBs and other internal assemblies.

You can perform a sweep generator self-test at any time during normal operation by pressing **SYSTEM** and then the System Menu soft-key **Selftest**.

If the sweep generator fails self-test, an error message(s) is displayed on the front panel data display. These error messages describe the malfunction and, in most cases, provide an indication of what has failed. Table 6-1, next page, is a summary listing of the self-test error messages. Included for each is a description of the probable cause(s), whether or not the 681XXB is still operable, and if operable, what operational degradation can be expected.

NOTE

Self-test error messages normally indicate the failure of an internal component or assembly of the sweep generator. Do **not** attempt to repair the 681XXB. Refer the instrument to a qualified service technician.

Table 6-1. *Self-Test Error Messages (1 of 4)*

| Error Message | Description/Remarks |
|--|---|
| Error 100 DVM Ground Offset Failed | Indicates a calibration-related problem. Do Not Attempt to Operate! Refer the instrument to a qualified service technician. |
| Error 101 DVM Positive 10V Reference | Indicates either a calibration-related problem or a defective +10 Volt reference. Do not Attempt to Operate! Refer the instrument to a qualified service technician. |
| Error 102 DVM Negative 10V Reference | Indicates either a calibration-related problem or a defective –10 Volt reference. Do not Attempt to Operate! Refer the instrument to a qualified service technician. |
| Error 105 Power Supply Voltage(s) out of Regulation | Indicates one or more of the voltages from the power supply are out of regulation. Do Not Attempt to Operate! Refer the instrument to a qualified service technician. |
| Error 106 Power Supply not Locked | Indicates the power supply is not phase-locked to the 400 kHz reference frequency. The 681XXB is still operable in a degraded mode. The RF output may contain more spurious signals than normal. |
| Error 107 Sweep Time Check Failed | Indicates the sweep timing is out of tolerance or has failed. If analog sweeps can be obtained, the 681XXB is still operable in a degraded mode. If analog sweeps can not be obtained, the 681XXB is operable only in CW or step sweep frequency modes. |
| Error 108 Crystal Oven Cold | Indicates the 100 MHz crystal oven or the Option 16 high-stability 10 MHz crystal oscillator has not reached operating temperature. The 681XXB is still operable, but frequency accuracy and stability may be degraded. |
| Error 109 The 100MHz Reference is not Locked to the External Reference | Indicates the reference loop is not phase-locked to the external 10 MHz reference. The reference loop may phase-lock to the internal 100 MHz time base; consequently, the 681XXB would continue to operate normally. |
| Error 110 The 100MHz Reference is not Locked to the High Stability 10MHz Crystal Oscillator | Indicates the reference loop is not phase-locked to the optional, high stability 10 MHz crystal oscillator. The reference loop may phase-lock to the internal 100 MHz time base; consequently, the 681XXB would continue to operate normally. |
| Error 111 Fine Loop Osc Failed | Indicates one or more of the oscillators within the fine loop is not phase-locked. The 681XXB is still operable but the accuracy and stability of frequency outputs are greatly reduced. |
| Error 112 Coarse Loop Osc Failed | Indicates the coarse loop oscillator is not phase-locked. The 681XXB is still operable but the accuracy and stability of the frequency outputs are greatly reduced. |
| Error 113 Yig Loop Osc Failed | Indicates the YIG loop is not phase-locked. The 681XXB is still operable but the accuracy and stability of the frequency outputs are greatly reduced. |
| Error 114 Down Converter LO not Locked | Indicates the local oscillator in the down converter assembly is not phase-locked. The 681XXB is still operable but the accuracy and stability of frequency outputs below 2 GHz is greatly reduced. |

Table 6-1. Self-Test Error Messages (2 of 4)

| Error Message | Description/Remarks |
|--|---|
| Error 115 Not Locked Indicator Failed | Indicates failure of the not phase-locked indicator circuit. The 681XXB is still operable but an error message will not appear on the data display when the output frequency is not phase-locked. |
| Error 116 FM Loop Gain Check Failed | Indicates FM loop has failed or the loop gain is out of tolerance. The 681XXB is still operable but frequency accuracy and stability are degraded. |
| Error 117 Linearizer Check Failed | Indicates a failure of the Linearizer DAC on the A12 PCB. The 681XXB is still operable but frequency accuracy of the RF output is degraded. |
| Error 118 Switchpoint DAC Failed | Indicates a failure of the Switchpoint DAC on the A12 PCB. The 681XXB will not produce analog sweeps but should operate normally in CW and step sweep modes. |
| Error 119 Center Frequency Circuits Failed | Indicates a failure of the center frequency circuitry on the A12 PCB. Do Not Attempt to Operate! Refer the instrument to a qualified service technician. |
| Error 120- Delta-F Circuits Failed | Indicates a failure of the ΔF Width DAC on the A12 PCB. The 681XXB will not generate ΔF analog sweeps but should produce ΔF step sweeps. |
| Error 121 Unleveled Indicator Failed | Indicates failure of the not leveled detector circuitry on the A10 PCB. The 681XXB is still operable but a warning message will not appear when the RF output goes unleveled. |
| Error 122 Level Reference Failed | Indicates a failure of the level reference circuitry on the A10 PCB. Use caution and always determine the output power level when operating the 681XXB in this condition. |
| Error 123 Detector Log Amp Failed | Indicates a failure of the level detector log amplifier circuitry on the A10 PCB. Use caution and always determine the output power level when operating the 681XXB in this condition. |
| Error 124 Full Band Unlocked and Unleveled | Indicates a failure of both YIG-tuned oscillators. Do Not Attempt to Operate! Refer the instrument to a qualified service technician. |
| Error 125 8.4 – 20 GHz Unlocked and Unleveled | Indicates a failure of the 8.4 to 20 GHz YIG-tuned oscillator. Do Not Attempt to Operate! Refer the instrument to a qualified service technician. |
| Error 126 2 – 8.4 GHz Unlocked and Unleveled | Indicates a failure of the 2 to 8.4 GHz YIG-tuned oscillator. Do Not Attempt to Operate! Refer the instrument to a qualified service technician. |
| Error 127 Detector Input Circuit Failed | Indicates a failure of the level detector input circuitry on the A10 PCB. Use caution and always determine the output power level when operating the 681XXB in this condition. |
| Error 128 .01 – 2 GHz Unleveled | Indicates a failure of the Down Converter leveling circuitry. The 681XXB operates normally but will have unleveled RF output in the 0.01 - 2 GHz frequency range. |

Table 6-1. *Self-Test Error Messages (3 of 4)*

| Error Message | Description/Remarks |
|--|---|
| Error 129 Switched Filter or Level Detector Failed | Indicates a failure of either the switched filter or level detector circuitry. The 681XXB may or may not produce an RF output. Use caution and always determine the output power level when operating the 681XXB in this condition. |
| Error 130 2 – 3.3 GH Switched Filter | Indicates a failure in the 2 - 3.3 GHz switched filter path within the switched filter assembly. The 681XXB may or may not produce an RF output in this frequency range. Use caution and always determine the output power level when operating the 681XXB in this condition. |
| Error 131 3.3 – 5.5 GH Switched Filter | Indicates a failure in the 3.3 - 5.5 GHz switched filter path within the switched filter assembly. The 681XXB may or may not produce an RF output in this frequency range. Use caution and always determine the output power level when operating the 681XXB in this condition. |
| Error 132 5.5 – 8.4 GH Switched Filter | Indicates a failure in the 5.5 - 8.4 GHz switched filter path within the switched filter assembly. The 681XXB may or may not produce an RF output in this frequency range. Use caution and always determine the output power level when operating the 681XXB in this condition. |
| Error 133 8.4 – 13.25 GH Switched Filter | Indicates a failure in the 8.4 - 13.25 GHz switched filter path within the switched filter assembly. The 681XXB may or may not produce an RF output in this frequency range. Use caution and always determine the output power level when operating the 681XXB in this condition. |
| Error 134 13.25 – 20 GH Switched Filter | Indicates a failure in the 13.25 - 20 GHz switched filter path within the switched filter assembly. The 681XXB may or may not produce an RF output in this frequency range. Use caution and always determine the output power level when operating the 681XXB in this condition. |
| Error 135 Modulator or Driver Failed | Indicates a failure of the modulator in the switched filter assembly or the modulator driver circuitry on the A9 PCB. The 681XXB may or may not produce an RF output. Use caution and always determine the output power level when operating the 681XXB in this condition. |
| Error 138 SDM Unit or Driver Failed | Indicates a failure of the switched doubler module (SDM) or SDM bias regulator circuitry on the A14 PCB. The 681XXB is still operable but it will not produce an RF output in the 20 - 40 GHz frequency range. |
| Error 139 32 – 40 GHz SDM Section Failed | Indicates a failure in the 32 - 40 GHz switched doubler filter path within the SDM. The 681XXB is still operable but it will not produce an RF output in the 32 - 40 GHz frequency range. |
| Error 140 25 – 32 GHz SDM Section Failed | Indicates a failure in the 25 - 32 GHz switched doubler filter path within the SDM. The 681XXB is still operable but it will not produce an RF output in the 25 - 32 GHz frequency range. |
| Error 141 20 – 25 GHz SDM Section Failed | Indicates a failure in the 20 - 25 GHz switched doubler filter path within the SDM. The 681XXB is still operable but it will not produce an RF output in the 20 - 25 GHz frequency range. |

Table 6-1. *Self-Test Error Messages (4 of 4)*

| Error Message | Description/Remarks |
|---|---|
| Error 142 Sample and Hold Circuit Failed | Indicates a failure of the sample and hold circuitry on the A10 PCB. The 681XXB still operates normally but the RF output may be unlevelled during square wave modulation. |
| Error 143 Slope DAC Failed | Indicates a failure of the level slope DAC on the A10 PCB. The 681XXB still operates normally but RF output level flatness may be affected during analog frequency sweeps. |
| Error 144 RF was Off when Selftest started. Some tests were not performed. | Indicates that some self-tests were not performed because RF Output was selected OFF on the 681XXB front panel. Press the OUTPUT key to turn RF Output ON and run the instrument self-test again. |

**Normal
Operation
Error and
Warning/
Status
Messages**

When an abnormal condition is detected during operation, the 681XXB displays an error message to indicate that the output is abnormal or that a signal input or data entry is invalid. It also displays warning messages to alert the operator to conditions that could cause an inaccurate signal generator output. Status messages to remind the operator of current menu selections or settings are also generated.

Table 6-2 is a summary list of possible error messages that can be displayed during normal operations. Table 6-3 is a summary list of possible warning/status messages.

Table 6-2. *Possible Error Messages during Normal Operations*

| Error Message | Description |
|----------------------|--|
| ERROR | Displayed (on the frequency mode title bar) when (1) the output frequency is not phase-locked or (2) an invalid entry causes a frequency range error. |
| LOCK ERROR | Displayed (in the frequency parameters area) when the output frequency is not phase-locked. The frequency accuracy and stability of the RF output is greatly reduced. Normally caused by an internal component failure. Run self-test to verify malfunction. |
| RANGE | Displayed (in the frequency parameters area) when (1) the analog sweep start frequency entered is greater than the stop frequency, (2) the dF value entered results in a sweep outside the range of the instrument, (3) the step size value entered is greater than the sweep range, or (4) the number of steps entered results in a step size of less than 1 kHz (0.1 Hz with Option 11) or 0.1 dB. Entering valid values usually clears the error. |
| ERR | Displayed (in the modulation status area) when either the external AM modulating signal or the external FM modulating signal exceeds the input voltage range. In addition, the message " Reduce AM (FM) Input Level " appears at the bottom of the AM (FM) status display. AM (FM) will be turned off until the modulating signal is in the input voltage range. |
| SLAVE | Displayed (in the frequency parameters area of the Master 681XXB) during master-slave operation when the slave frequency offset value entered results in a CW frequency or frequency sweep outside the range of the slave 681XXB. Entering a valid offset value clears the error. |

Table 6-3. *Possible Warning/Status Messages during Normal Operation*

| Warning/Status Message | Description |
|-------------------------------|--|
| OVN COLD | This warning message indicates that the 100 MHz Crystal oven (or the 10 MHz Crystal oven if Option 16 is installed) has not reached operating temperature. Normally displayed during a cold start of the sweep generator. If the message is displayed during normal operation, it could indicate a malfunction. Run self-test to verify. |
| UNLEVELED | Displayed when the RF output goes unleveled. Normally caused by exceeding the specified leveled-power rating. Reducing the power level usually clears the warning message. If the warning message is displayed only when AM is selected ON, the modulating signal may be driving the RF output unleveled. Reducing the modulating signal or adjusting the power level usually clears the warning. |
| UNLOCKED | When FM is selected ON, this warning message appears indicating that the instrument is not phase-locked during the FM mode of operation. |
| EXT REF | This status message indicates that an external 10 MHz signal is being used as the reference signal for the 681XXB. |
| OFFSET | This status message indicates that a constant (offset) has been applied to the displayed power level. |
| SLOPE | This status message indicates that a power slope correction has been applied to the ALC. |
| USER 1...5 | This status message indicates that a user level flatness correction power-offset table has been applied to the ALC. |
| SS MODE | This status message indicates that the 681XXB has been placed in a source lock mode for operation with a 360B Vector Network Analyzer. |

6-3 TROUBLESHOOTING

Table 6-4 provides procedures for troubleshooting common malfunctions encountered during operation of the sweep generator. Included are procedures for troubleshooting faults that do not produce error messages, such as, failure to power up and unexpected shutdown.

Table 6-4. *Troubleshooting (1 of 3)*

**Sweep Generator will not turn on
(OPERATE light is OFF)**

Normal Operation: When the 681XXB is connected to the power source, the OPERATE light should illuminate and the instrument should power up.

Step 1 Disconnect the 681XXB from the power source, then check the line fuse on the rear panel.

- If the fuse is defective, replace (see page 6-13).
- If the fuse is good, go to the next step.

Step 2 Check to see if power is available at the power receptacle.

- If not, move to a working receptacle.
- If power is available, go to the next step.

Step 3 Check the power cable.

- If defective, replace.
- If good, call a service technician.

**Sweep Generator will not turn on
(OPERATE light is ON)**

Normal Operation: When the 681XXB is connected to the power source, the OPERATE light should illuminate and the instrument should power up.

- If the OPERATE light illuminates but the unit fails to power up, the 681XXB has an internal component failure. Call a service technician.
-

Table 6-4. Troubleshooting (2 of 3)

Sweep Generator Quits During Operation (OPERATE light remains on)

Trouble Description: The sweep generator operates for some time, then shuts down (OPERATE light remains on). After a short period, the sweep generator resumes normal operation. This is an indication that the 681XXB has reached an excessive operating temperature.

Step 1 Check that the fan is still operating during the time that the instrument is shut down.

- If the fan is still operating, clean the air filter (see page 6-14).
- If the fan is not operating, call a service technician.

LOCK ERROR is Displayed

Trouble Description: This message is displayed in the frequency parameters area to indicate that the output frequency is not phase-locked. It is normally caused by an internal component failure.

Step 1 Perform a self-test of the sweep generator by pressing the System Menu soft-key **Selftest** .

- If self-test does not result in an error message(s), resume normal operation.
 - If an error message(s) is displayed, call a service technician.
-

Table 6-4. Troubleshooting (3 of 3)

UNLEVELED is Displayed

Trouble Description: This message is displayed to indicate that the RF output is unlevelled.

Step 1 Check that the output power does not exceed the specified leveled-power rating and that the RF OUTPUT connector is terminated into a 50 Ω load.

- Reduce the power level to not exceed the specified leveled-power rating or terminate the RF OUTPUT connector with a 50 Ω load.
- If error message remains displayed, call a service technician.

RANGE is Displayed

Trouble Description: This message is displayed in the frequency parameters area to indicate that (1) the analog sweep start frequency entered is greater than the stop frequency, (2) the ΔF value entered results in a sweep outside the range of the instrument, (3) the step size value entered is greater than the sweep range, or (4) the number of steps entered results in a step size of less than 1 kHz (0.1 Hz with Option 11) or 0.1 dB.

Step 1 Check that (1) the analog sweep start frequency entered is not greater than the stop frequency, (2) the dF value entered does not try to set the frequency sweep outside the range of the sweep generator, (3) the step size entered is not greater than $F2$ minus $F1$, or (4) the number of steps entered does not result in a step size that is smaller than the resolution of the instrument.

- Enter a valid sweep start frequency, dF value, step size, or number of steps.
 - If the error message remains displayed, call a service technician.
-

6-4 ROUTINE MAINTENANCE

Routine maintenance that can be performed by the operator consists of replacing a defective line fuse, cleaning the fan filter, and cleaning the data display.

**Replacing
the Line Fuse**

The value of the line fuse used in the 681XXB is determined by the line voltage selection—a 5A line fuse for 110 Vac line voltage; a 2.5A line fuse for 220 Vac line voltage. These line fuse values are printed on the rear panel next to the fuse holder.

- Step 1** Disconnect the 681XXB from the power source.
- Step 2** Using a small flat-blade screwdriver, turn the fuse cap counter-clockwise and remove the fuse holder.
- Step 3** Replace the fuse in the fuse holder.
- Step 4** Install the fuse holder in the rear panel. Using the screwdriver, rotate the fuse cap clockwise to secure the fuse holder in place.
- Step 5** Reconnect the sweep generator to the power source.

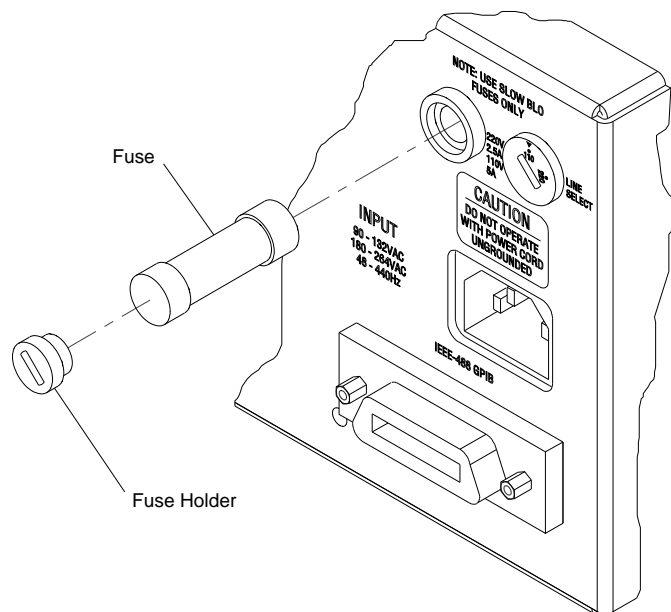

Figure 6-1. Replacing the Line Fuse

***Cleaning the
Fan Filter***

The sweep generator must always receive adequate ventilation. A blocked fan filter can cause the instrument to overheat and shut down. Check and clean the rear panel fan honeycomb filter periodically. Clean the fan honeycomb filter more frequently in dusty environments. Clean the filter as follows:

- Step 1** Remove the filter guard from the rear panel by pulling out on the four panel fasteners holding them in place (Figure 6-2).
- Step 2** Vacuum the honeycomb filter to clean it.
- Step 3** Install the filter guard back on the rear panel.
- Step 4** Press in on the panel fasteners to secure the filter guard to the rear panel.

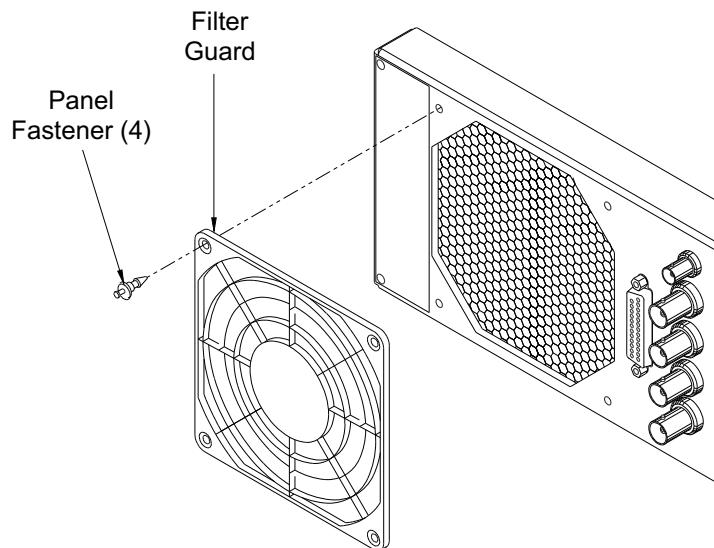

Figure 6-2. Removing/Replacing the Fan Filter

***Cleaning the
Data Display***

The data display of the sweep generator is protected by a plastic display filter. To clean the display filter, use mild soap or detergent and water, or a commercial window cleaner. When cleaning use a soft, lint-free cloth. Do *not* use abrasive cleaners, tissues, or paper towels which can scratch the plastic surface.

Chapter 7

Use With Other Instruments

Table of Contents

| | | |
|-----|--|------|
| 7-1 | INTRODUCTION | 7-3 |
| 7-2 | MASTER-SLAVE OPERATION | 7-4 |
| | Connecting the 68XXXBs | 7-4 |
| | Initiating Master-Slave Operation | 7-5 |
| | Master-Slave Operation | 7-7 |
| | Master-Slave Operation in VNA Mode | 7-7 |
| | Terminating Master-Slave Operation | 7-9 |
| 7-3 | USE WITH A 562 SNA | 7-10 |
| | Connecting the 681XXB to the 562 | 7-10 |
| 7-4 | USE WITH A 360B VNA | 7-12 |
| | Connecting the 681XXB to the 360B | 7-12 |
| | Modes of Operation | 7-13 |
| | Source Lock Mode | 7-13 |
| | Tracking Mode | 7-15 |

Chapter 7

Use With Other Instruments

7-1 INTRODUCTION

This chapter provides information and instructions for using the Series 681XXB Synthesized Sweep Generator with other WILTRON instruments. It contains the following:

- Instructions for interconnecting and operating any two 68XXXBs in a master-slave configuration.
- Instructions for connecting the 681XXB to a WILTRON Model 562 Scalar Network Analyzer so that it can be used as a signal source for the analyzer.
- Instructions for connecting the 681XXB to a WILTRON Model 360B Vector Network Analyzer and configuring the sweep generator so that it can be used as a signal source for the analyzer.

**7-2 MASTER-SLAVE
OPERATION**

Master-slave operation consists of connecting any two 68XXXBs together and configuring them so that they produce CW and synchronized, swept output signals at an operator-selectable frequency offset. One 68XXXB (the Master) controls the other (the Slave) via interface cables between their rear panel AUX I/O and SERIAL I/O connectors. The two units are phase-locked together by connecting them to the same 10 MHz reference time base.

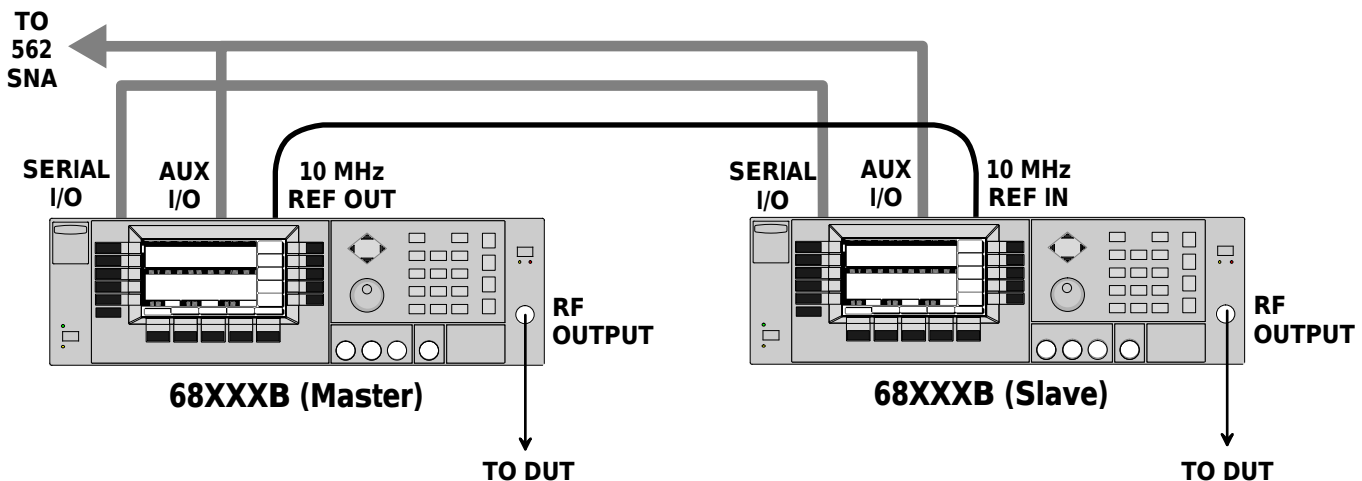

Figure 7-1. 68XXXB Configuration for Master-Slave Operation

**Connecting
the 68XXXBs**

Connect the two 68XXXBs, shown in Figure 7-1, as follows:

NOTE
When connecting two 68XXXBs together for Master-Slave operations, **always** use a WILTRON Master-Slave interface cable set, Part No. ND36329.

NOTE
If a Model 562 Scalar Network Analyzer is being used with the master-slave configuration, (1) connect the AUX I/O cable end labeled "SNA" to the rear panel AUX I/O connector on the 562 SNA and (2) connect a dedicated system bus cable (P/N 2100-1) between the Master 68XXXB rear panel IEEE-488 GPIB connector and the 562 SNA rear panel DEDICATED GPIB connector.

- Step 1** Connect the 3-port AUX I/O cable end labeled "MASTER" to the rear panel AUX I/O connector on the Master 68XXXB. Connect the AUX I/O cable labeled "SLAVE" to the rear panel AUX I/O connector on the Slave 68XXXB.
- Step 2** Connect the ends of the flat interface cable to the rear panel Serial I/O connectors on the Master and Slave 68XXXBs.
- Step 3** Connect one end of a coaxial cable to the rear panel 10 MHz REF OUT connector on the Master 68XXXB. Connect the other end to the rear panel 10 MHz REF IN connector on the Slave 68XXXB.
- Step 4** Connect the Master 68XXXB RF OUTPUT and the Slave 68XXXB RF OUTPUT

to the appropriate connections on the DUT.

**Initiating
Master-Slave
Operation**

The following paragraphs describe how to set up both 68XXXBs to perform master-slave operations. Use the CW Frequency Mode menu map (Chapter 4, Figure 4-2) to follow the menu sequences.

To initiate master-slave operation, turn on both 68XXXBs and place them in CW mode. The CW Menu (below) is displayed.

On the Master 68XXXB, press **Master Slave** to go

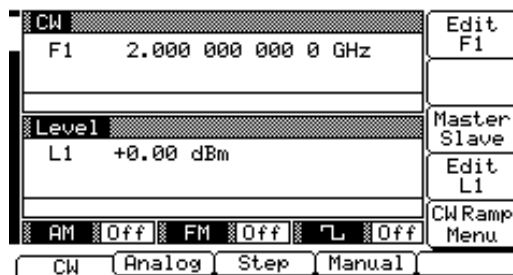

to the Master-Slave Menu display (below).

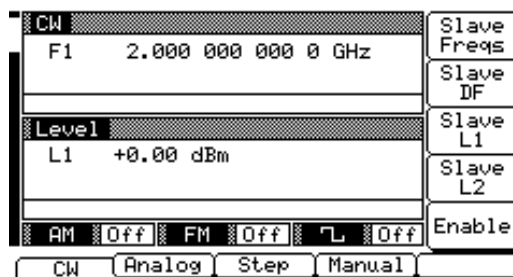

This menu lets you perform the following:

- Go to the Slave Frequencies List menu.
- Set the dF frequency for the Slave unit.
- Set the Slave unit's main power level (L1).
- Set the alternate sweep power level (L2) for the Slave unit.
- Turn master-slave operation on and off.

Press **Slave Freqs** to go to the Slave Frequencies List menu (next page).

NOTE
Master-slave operations are always initiated in the CW frequency mode. Once initiated, you then can change to a sweep frequency mode of operation by selecting the desired frequency mode on the Master 68XXXB.

NOTE
Upon reset, the slave frequencies (F0 - F9 and M0 - M9) return to the default values shown here.

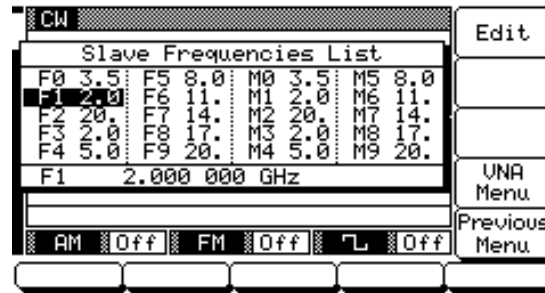

This menu lets you edit the listed frequencies for the Slave 68XXXB.

Use the cursor control key to select a frequency parameter from the list, then press **Edit** to edit its value. Edit the current frequency parameter value using the cursor control key or rotary data knob or enter a new value using the key pad and appropriate termination key. Press **Edit** again to close the open frequency parameter.

When you are finished editing the slave frequencies, press **Previous Menu** to return to the Master-Slave menu (below).

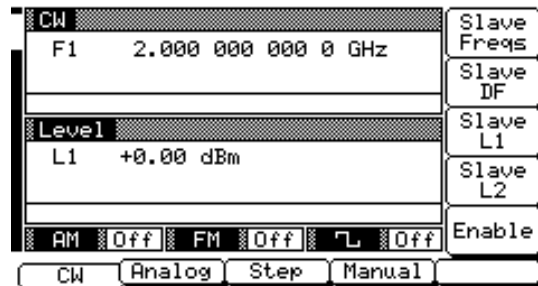

The Master-Slave menu lets you set the dF frequency and L1 and L2 power level parameters for the Slave unit.

Press **Slave DF** to open the dF frequency parameter.

Press **Slave L1** to open the main power level parameter.

Press **Slave L2** to open the alternate sweep power level parameter.

Open the parameter you wish to change, then edit the current value using the cursor control key or rotary data knob or enter a new value using the key

pad and appropriate termination key. When you have finished setting the open parameter, close it by pressing its menu soft-key or by making another menu selection.

Press **Enable** to begin master-slave operation.

Press **CW** to return to the CW menu.

Master-Slave Operation

During master-slave operation, the Slave unit is in remote mode under the direct control of the Master 68XXXB. The Slave unit displays the following:

- Its output CW frequency or sweep frequency range.
- Its output power level.
- The messages Remote and Local Lockout.

NOTE

The 562 SNA, when being used with the master-slave configuration, will not display markers.

The CW/sweep frequency settings on the Master 68XXXB define the master sweep, and the corresponding frequency settings on the Slave unit define the slave sweep. For example, if slave frequency F1 is set to 4 GHz and slave frequency F2 is set to 12 GHz, then the Slave unit will sweep from 4 to 12 GHz whenever the F1-F2 sweep range is selected on the Master 68XXXB. The Master 68XXXB will sweep from F1-F2 with the values of F1 and F2 defined in the Master unit's frequency list.

Master-Slave Operation in VNA Mode

In the VNA mode of master-slave operation, a Slave unit is coupled to a Master 68XXXB that is connected to a Model 360B Vector Network Analyzer in a source or dual source configuration. (Operating instructions for the vector network analyzer can be found in the Model 360B VNA Operation Manual, P/N 10410-00110.) The following paragraphs describe how to set up both 68XXXBs to perform master-slave operations in the VNA mode.

Place both 68XXXBs in CW mode. Then, on the Master unit, press **Master Slave** to go to the Master-Slave Menu display (page 7-5).

At the Master-Slave menu, press **Slave Freqs** to go to the Slave Frequencies List Menu display (next page).

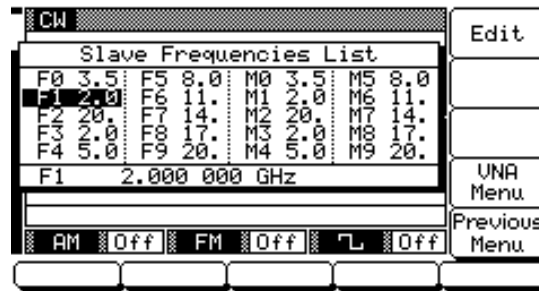

Press **VNA Menu** to go to the VNA Menu display (below).

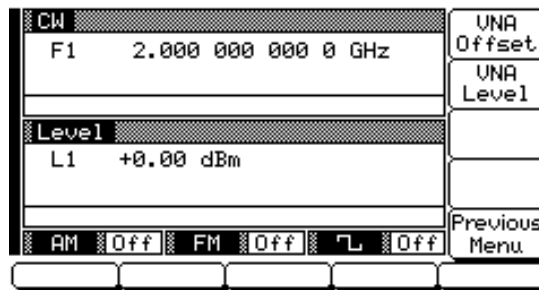

This menu lets you set the frequency offset and output power level for the Slave 68XXXB in the VNA mode.

Press **VNA Offset** to open the slave frequency offset parameter.

Press **VNA Level** to open the slave output power level parameter.

SLAVE

During master-slave operations in VNA mode, this error message is displayed on the Master 68XXXB when the slave offset value entered results in a CW frequency or frequency sweep outside the range of the slave 68XXXB. Entering a valid offset value clears the error.

Open the parameter you wish to change, then edit the current value using the cursor control key or rotary data knob or enter a new value using the keypad and appropriate termination key. When you have finished setting the open parameter, close it by pressing its menu soft-key or by making another menu selection.

Press **Previous Menu** to return to the Slave Frequencies List menu.

Return to the Master-Slave menu and press **Enable** to begin master-slave operation.

***Terminating
Master-Slave
Operation***

The following describes how to terminate master-slave operation and return the Slave 68XXXB to local (front panel) control.

On the Master 68XXXB, select CW mode.

At the CW Menu, press **Master Slave** to go to the Master Slave Menu display.

At the Master Slave Menu display, press **Enable**. This terminates master-slave operation and returns the Slave 68XXXB to local (front panel) control.

**7-3 USE WITH A 562
SCALAR NETWORK
ANALYZER**

The 681XXB is directly compatible with the WILTRON Model 562 Scalar Network Analyzer (SNA). The following paragraphs provide instructions for connecting the sweep generator to the 562 SNA so that it can be used as a signal source for the analyzer. Operating instructions for the network analyzer can be found in the Model 562 Scalar Network Analyzer Operation Manual, P/N 10410-00046.

**Connecting
the 681XXB
to the 562**

There are two ways the 681XXB can be connected to the 562 SNA—using the auxiliary I/O cable and the dedicated system bus cable or using discrete cables and the dedicated system bus cable. Instructions for both methods are provided in the following procedures.

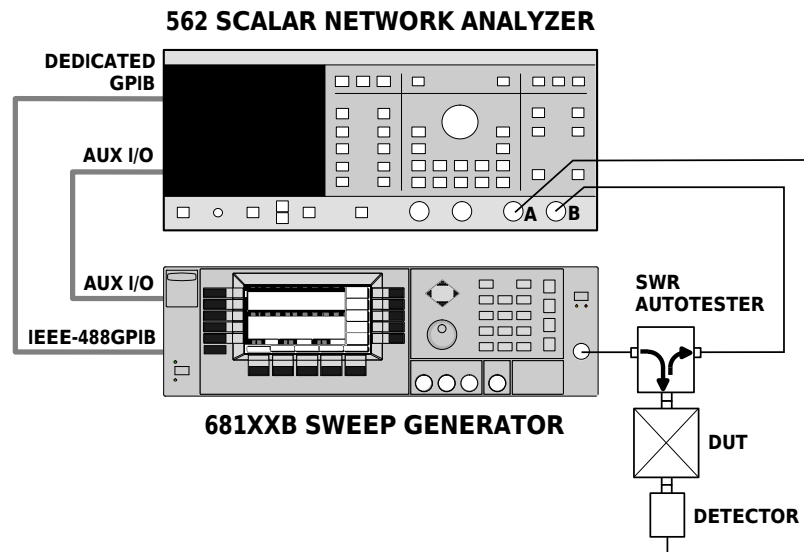

Figure 7-2. 562 SNA to 681XXB Sweep Generator Connections

Using the Auxiliary I/O Cable

Connect the 681XXB to the 562 SNA as shown in Figure 7-2.

Step 1 Connect one end of the Auxiliary I/O cable (P/N 806-7) to the 562 rear panel AUX I/O connector. Connect the other end of the cable to the 681XXB rear panel AUX I/O connector.

Step 2 Connect one end of the dedicated system bus cable (P/N 2100-1) to the 562 rear panel DEDICATED GPIB connector. Connect the other end of the cable to the

NOTE
The 681XXB's GPIB address should be set to 5 (the default address setting) for operation with a 562 SNA. To verify or change the GPIB address setting refer to Configuring the GPIB on page 3-71.

681XXB rear panel IEEE-488 GPIB connector.

Step 3 Turn on the 681XXB and the 562. The system is now ready to operate.

Using Discrete Cables

Connect the 681XXB to the 562 SNA as follows:

Step 1 Connect one end of a coaxial cable to the 681XXB rear panel HORIZ OUT connector. Connect the other end of the cable to the 562 rear panel HORIZONTAL INPUT /OUTPUT connector.

Step 2 Connect one end of a coaxial cable to the 681XXB rear panel SEQ SYNC OUT connector. Connect the other end of the cable to the 562 rear panel SEQ SYNC INPUT connector.

Step 3 Connect one end of a coaxial cable to the 681XXB rear panel MARKER OUT connector. Connect the other end of the cable to the 562 rear panel VIDEO MARKER INPUT connector.

Step 4 Connect one end of a coaxial cable to the 681XXB rear panel DWELL IN connector. Connect the other end of the cable to the 562 rear panel SWEEP DWELL OUTPUT connector.

Step 5 Connect one end of the dedicated system bus cable (P/N 2100-1) to the 562 rear panel DEDICATED GPIB connector. Connect the other end of the cable to the 681XXB rear panel IEEE-488 GPIB connector.

Step 6 Turn on the 681XXB and the 562. The system is now ready to operate.

NOTES

The 562 SNA will only accept and display the nine video markers, F1 thru F9, from the 681XXB.

When performing amplifier testing *only* use the 681XXB power level, L1.

**7-4 USE WITH A 360B
VECTOR NETWORK
ANALYZER**

The 681XXB sweep generator is compatible with the WILTRON Model 360B Vector Network Analyzer (VNA). The following paragraphs provide instructions for connecting the 681XXB to the 360B VNA and configuring the sweep generator so that it can operate as a signal source for the analyzer. Operating instructions for the vector network analyzer can be found in the Model 360B Vector Network Analyzer Operation Manual, P/N 10410-00110.

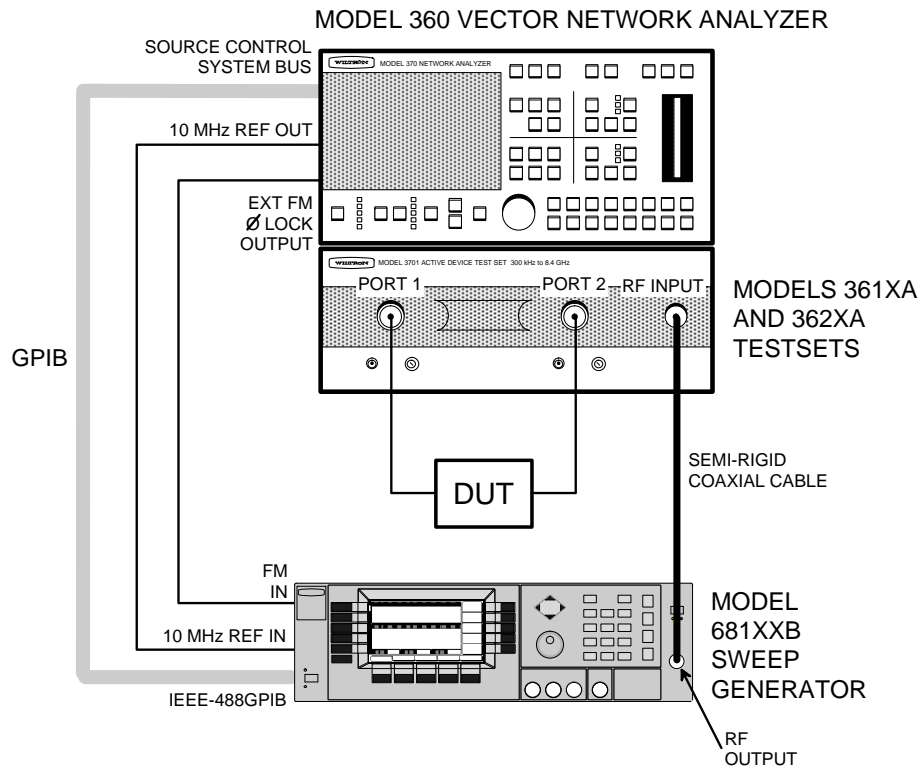

Figure 7-3. 360B VNA to 681XXB Sweep Generator Connections

**Connecting
the 681XXB
to the 360B**

Connect the 681XXB sweep generator to the 360B vector network analyzer as shown in Figure 7-3.

Step 1 Connect one end of a coaxial cable to the 681XXB rear panel FM IN connector. Connect the other end to the 360B rear panel EXT FM Ø LOCK OUTPUT connector.

Step 2 Connect one end of a coaxial cable to the 681XXB rear panel 10 MHz REF IN connector. Connect the other end to the 360B rear panel 10 MHz REF OUT connector.

If the 681XXB contains an Option 16 high-stability time base, connect the coaxial cable between the 681XXB rear panel 10 MHz REF OUT connector and the 360B rear panel 10 MHz REF IN connector.

Step 3 Connect one end of a GPIB cable, 1 meter in length, to the 681XXB rear panel IEEE-488 GPIB connector. Connect the other end of the cable to the 360B rear panel SOURCE CONTROL SYSTEM BUS connector.

Step 4 Turn on the 681XXB and configure it as described in the following paragraphs.

**Modes of
Operation**

There are two 360B VNA receiver modes of operation that are used with the 681XXB—the 360B source lock mode and the 360B tracking mode. The configuration and operation of the 681XXB for both modes of operation are described in the following paragraphs.

**Source Lock
Mode**

When operating in source lock mode, the 360B phase locks the frequency output of the 681XXB. This is accomplished by sending a dc control voltage to the FM input on the 681XXB. Due to the inherent resolution of the 360B's synthesized local oscillators, frequency resolution is limited to 100 kHz intervals.

Source Lock Mode Configuration

In order for the 681XXB to operate with a 360B in source lock mode, the sweep generator must be placed in the SS Mode of operation.

To place the sweep generator in SS Mode, first press the main menu key **SYSTEM**. At the System Menu display, press **Config**. The System Configuration Menu (shown below) is displayed.

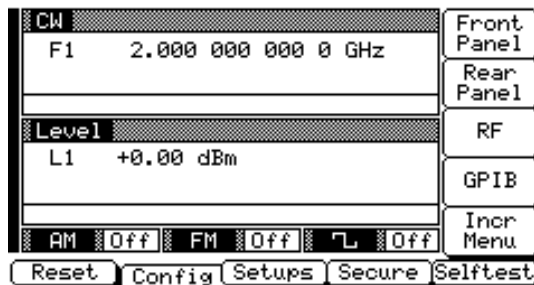

At the System Configuration menu, press **GPIB** . The Configure GPIB Menu (shown below) is displayed.

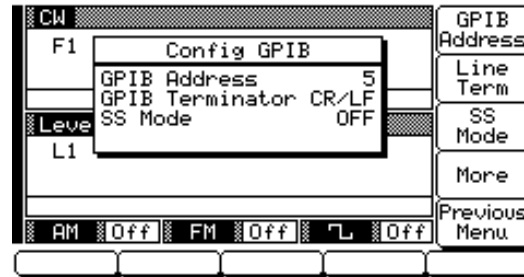

Verify that the GPIB address and terminator shown on the display match the System Bus source address and data terminator that are set on the 360B VNA.

If the address of the 681XXB on the System Bus needs changing, press **GPIB Address** . Enter the new address using the cursor control key or the data entry keypad and the terminator key

**HZ
ms
ADRS**

The new GPIB address will appear on the display.

To change the data terminator, press **Line Term** to select the correct GPIB data delimiter.

Press **SS Mode** to turn on SS mode. This places the 681XXB in a source lock mode.

The sweep generator is now configured for 360B source lock mode operation.

Initiating 360B Source Lock Mode Operations

Turn on the 360B and configure it for source lock mode of operation. (Refer to the 360B VNA operation manual.) Once configured, the 360B takes control of the sweep generator.

When the 360B takes control, the display of all parameters on the 681XXB is disabled and the messages SS MODE, Secure Mode Active, and Remote appear on the front panel display.

SS MODE

When SS Mode is selected on, this message is displayed (in the frequency mode title bar) on all menu displays to remind the operator that the 681XXB is in a source lock mode.

NOTE

A 360B VNA that is using a 3612A, 3613A, 3622A, 3623A, or 3631A Test Set and a 681XXB Source in SS Mode should not be operated above 60 GHz because it will fail to lock. For operations above 60 GHz, use the 681XXB Source in tracking mode.

Terminating 360B Source Lock Mode Operations

To terminate 360B VNA source lock mode operations, you must first return the 681XXB to local control and then turn off the SS Mode.

To return the 681XXB to local control, turn off the 360B VNA.

On the 681XXB, press **SYSTEM**, then **Reset**. This turns off the Secure mode.

Next, press **SYSTEM**, then **Config** to access the System Configuration Menu display.

At the System Configuration Menu, press **GPIB**. When the Configure GPIB Menu (shown below) is displayed, press **SS Mode** to turn the SS mode off.

Tracking Mode

When operating in tracking mode, the 360B steers its second local oscillator frequency and phase signal so as to phase-lock itself to the reference signal from the 681XXB. Due to the inherent resolution of the 360B's frequency readout, frequency resolution is limited to 1 kHz intervals.

Tracking Mode Configuration

In order for the 681XXB to operate with a 360B in tracking mode, the sweep generator must be operating in normal mode (SS Mode off). In addition, its GPIB address and data terminator must match the System Bus source address and data terminator that are set on the 360B VNA.

To verify the GPIB address and data terminator or to turn the SS mode off, press **SYSTEM**. At the System Menu display, press **Config**. When the System Configuration Menu is displayed, press **GPIB**. The Configure GPIB Menu (shown below) is displayed.

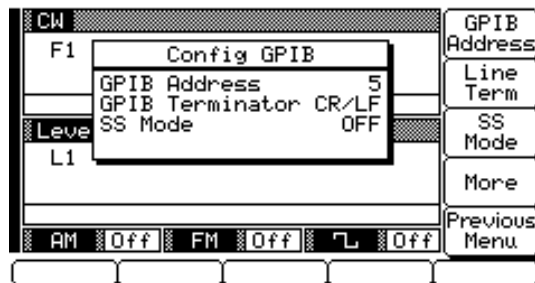

If the address of the 681XXB on the System Bus needs changing, press **GPIB Address** . Enter the new address using the cursor control key or the data entry keypad and the terminator key

**HZ
ms
ADRS**

The new GPIB address will appear on the display.

To change the data terminator, press **Line Term** to select the correct GPIB data delimiter.

To turn SS mode off, press **SS Mode** .

The sweep generator is now configured for 360B tracking mode operation.

Initiating 360B Tracking Mode Operations

Turn on the 360B and configure it for tracking mode of operation. (Refer to the 360B VNA operation manual.) Once configured, the 360B should take control of the sweep generator.

When the 360B takes control, the display of all parameters on the 681XXB is disabled and the messages Secure Mode Active and Remote appear on the front panel display.

Terminating 360B Tracking Mode Operations

To terminate 360B VNA tracking mode operations, you must first return the 681XXB to local control and then turn off the Secure mode.

To return the 681XXB to local control, turn off the 360B VNA.

On the 681XXB, press **SYSTEM** , then **Reset** . This turns off the Secure mode.

Appendix A

Rear Panel Connectors

A-1 INTRODUCTION

This appendix provides descriptions for the rear panel connectors on a typical Series 681XXB Synthesized Sweep Generator.

A-2 REAR PANEL CONNECTORS

Figure A-1 provides a illustration of the rear panel and describes the rear panel connectors.

A-3 CONNECTOR PINOUT DIAGRAMS

Figures A-2 and A-3 provide pinout diagrams and descriptions for the AUX I/O and IEEE-488 GPIB multipin connectors on the rear panel.

REAR PANEL CONNECTORS

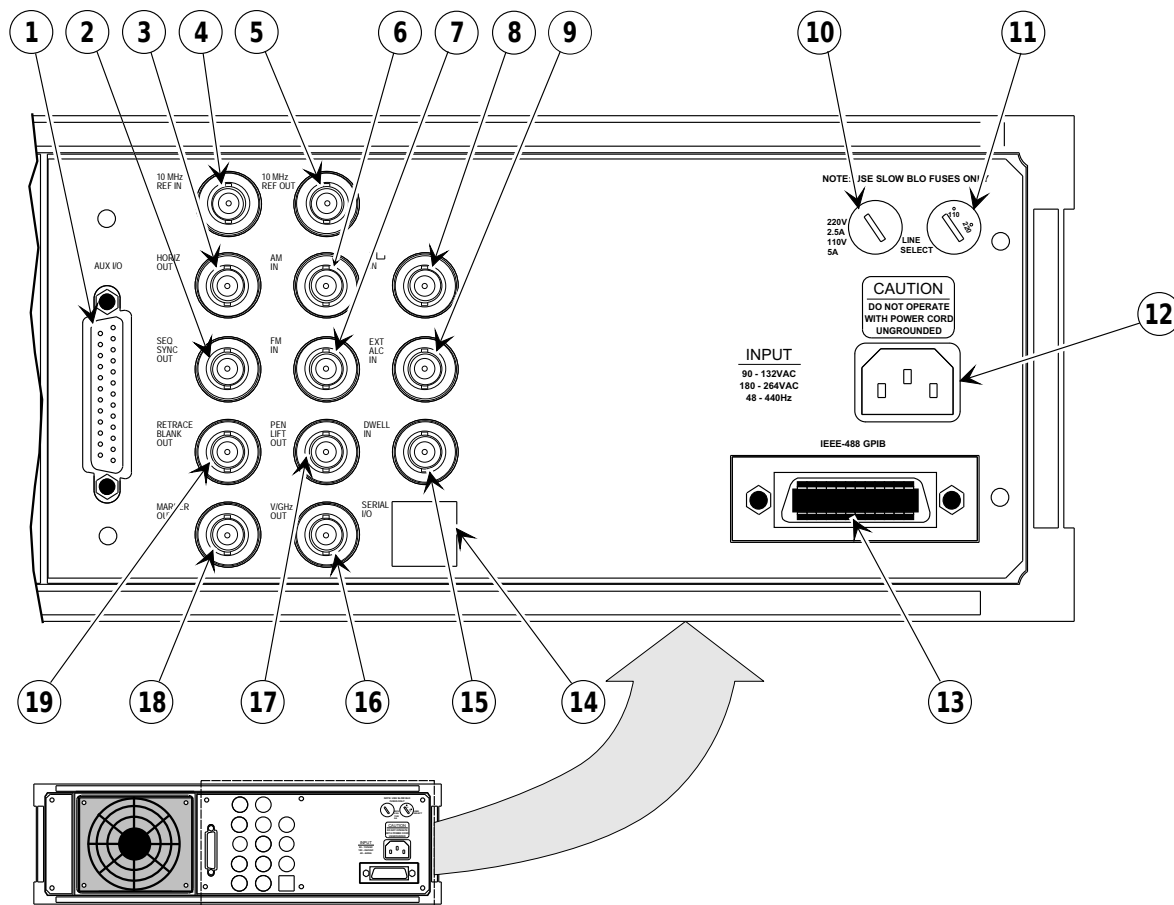

- 1 **AUX I/O:** 25-pin connector that provides for single cable interface with another sweep generator (master-slave operation) and with other WILTRON instruments such as the WILTRON 562 Scalar Network Analyzer. A pinout diagram for this connector is shown in Figure A-2.
- 2 **SEQ SYNC OUT:** Provides a +5V signal during sweep retrace, at bandswitching points, and during each frequency step in step sweep mode. Also, when video markers are selected, provides -5V marker pulses and a -10V selected marker pulse during forward sweep. BNC connector.
- 3 **HORIZ OUT:** Provides a 0V to 10V ramp during all sweep modes, regardless of sweep width. In the CW mode, provides a voltage between 0V and 10V proportional to the full frequency

- 4 **10 MHz REF IN:** Accepts an external 10 MHz ± 100 Hz, 0 to 10 dBm time-base signal. Automatically disconnects the internal high-stability, time-base option, if installed. BNC connector, 50 Ω impedance.
- 5 **10 MHz REF OUT:** Provides a 0.5 Vp-p, AC coupled, 10 MHz signal derived from the internal frequency standard of the sweep generator. BNC connector, 50 Ω impedance.
- 6 **AM IN:** Accepts an external modulating signal to produce AM on the RF output. AM sensitivity (linear or log) and input impedance (50 Ω or 600 Ω) are selectable via front panel menu or GPIB. BNC connector.

Figure A-1. Rear Panel, Series 681XXB Synthesized Sweep Generator (1 of 2)

REAR PANEL CONNECTORS

- 7 **FM IN:** Accepts an external modulating signal to produce FM on the RF output. FM sensitivity and input impedance (50Ω or 600Ω) are selectable via front panel menu or GPIB. BNC connector.
- 8 **□ IN:** Accepts an external TTL level signal to square wave (pulse) modulate the RF output. BNC connector.
- 9 **EXT ALC IN:** Provides for leveling the RF output signal externally with either a remote detector or a power meter. Connector accepts a positive or negative 0.5—500 mV signal from a remote detector or a ±1V signal from a remote power meter. BNC connector.
- 10 **Line Fuse:** Provides over-voltage/current protection for sweep generator circuits during operation and standby. Unit requires a 5A, slow blow fuse for 110 Vac line voltage or a 2.5A, slow blow fuse for 220 Vac line voltage.
- 11 **LINE SELECT Switch:** Provides selection of 110 or 220 Vac line voltages. When 110 Vac is selected, the 681XXB accepts 90-132 Vac, 48-440 Hz line voltage; when 220 Vac is selected, the 681XXB accepts 180-264 Vac, 48-440 Hz line voltage.
- 12 **Input Line Voltage Receptacle:** Provides for connecting line voltage to the 681XXB.
- 13 **IEEE-488 GPIB:** 24-pin connector that provides for remotely controlling the sweep generator from an external controller via the IEEE-488 bus (GPIB). A pinout diagram for this connector is shown in Figure A-3.
- 14 **SERIAL I/O:** Provides access to two RS-232 terminal ports to support service and calibration functions and master-slave operations. RJ45 connector.
- 15 **DWELL IN:** Accepts an external TTL low-level signal to stop the sweep in both analog- and step-sweep modes. The sweep resumes when the signal is removed.
- 16 **V/GHz OUT:** Provides a reference voltage relative to the frequency of the RF output (see table below). BNC connector.

| Model Number | V/GHz Output |
|--------------|--------------|
| 68137B | 1.0V/GHz |
| 68147B | 1.0V/GHz |
| 68153B | 0.5V/GHz |
| 68159B | 0.5V/GHz |
| 68163B | 0.5V/GHz |
| 68169B | 0.5V/GHz |

- 17 **PEN LIFT OUT:** Provides relay contacts for lifting and dropping a chart recorder's pen during bandswitch points and sweep retrace. Selection of normally-open or normally-closed relay contacts can be made from the front panel menu. BNC connector.
- 18 **MARKER OUT:** Provides a -5V or +5V output at each frequency marker if video markers have been selected. Selection of signal polarity can be made from the front panel menu. BNC connector.
- 19 **RETRACE BLANK OUT:** Provides a -5V or +5V output during sweep retrace. Selection of signal polarity can be made from the front panel menu. BNC connector.

Figure A-1. Rear Panel, Series 681XXB Synthesized Sweep Generator (2 of 2)

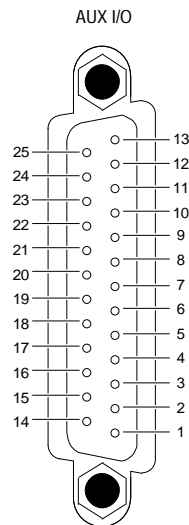

| PIN | SIGNAL NAME | SIGNAL DESCRIPTION |
|-----|------------------|--|
| 1 | HORIZ OUTPUT | <i>Horizontal Sweep Output:</i> Provides a 0V at beginning and +10V at end of sweep for all sweep modes, regardless of sweep width. In the CW mode, the voltage is proportional to frequency between 0V at low end and +10V at the high end of range. In CW mode, if CW Ramp is enabled, a repetitive, 0V to +10V ramp is provided. The ramp speed is adjusted by the Sweep Time function. |
| 2 | GND | Chassis Ground |
| 3 | SEQ SYNC | <i>Sequential Sync Output:</i> Provides a +5V signal during sweep retrace, at bandswitching points, and during each frequency step in step sweep mode, -5V during markers, and -10V during the selected marker. |
| 4 | L ALT ENABLE | <i>L-Alternate Enable Output:</i> Provides a TTL low-level signal which indicates that the alternate sweep mode is active. |
| 5 | MARKER OUTPUT | <i>Marker Output:</i> Provides a +5V or -5V signal during a marker. Signal polarity selected from a front panel menu. |
| 6 | RETRACE BLANKING | <i>Retrace Blanking Output:</i> Provides a +5V or -5V signal coincident with sweep retrace. Signal polarity selected from a front panel menu. |
| 7 | L ALT SWP | <i>L-Alternate Sweep Output:</i> Provides a TTL low-level signal to indicate that the primary sweep is in progress or a TTL high-level signal to indicate that the alternate sweep is in progress. |
| 8 | Shield | Cable Shield/Chassis Ground |
| 9 | TRIGGER OUTPUT | <i>Trigger Output:</i> Provides a TTL low-level trigger signal for external devices or instruments. |
| 10 | SWP DWELL OUT | <i>Sweep Dwell Output:</i> Provides an open-collector output which goes to ground when the sweep is dwelled at the start, stop, and bandswitching frequencies, and at the markers. |
| 11 | LOCK STATUS | <i>Lock Status Output:</i> Provides a TTL high-level signal when the frequency is phase-locked. |
| 12 | RXb | <i>RXb:</i> Serial Data Input to the processor (/t1). |
| 13 | EXT TRIGGER | <i>External Trigger:</i> Accepts a TTL low-level signal of 1 μ s width to trigger a sweep. |

Figure A-2. Pinout Diagram, AUX I/O Connector (1 of 2)

| PIN | SIGNAL NAME | SIGNAL DESCRIPTION |
|-----|------------------|---|
| 14 | V/GHz | <i>V/GHz Output:</i> Provides a reference voltage relative to the RF output frequency (1.0 V/GHz for Models 68137B and 68147B; 0.5 V/GHz for Models 68153B, 68159B, 68163B, and 68169B). |
| 15 | EOS INPUT | <i>End-of-Sweep Input:</i> Accepts a TTL high-level signal to tell the sweep generator to begin the end of sweep dwell. |
| 16 | EOS OUTPUT | <i>End-of-Sweep Output:</i> Provides a TTL high-level signal when the sweep generator has begun the end of sweep dwell. |
| 17 | AUX 1 | <i>Aux 1:</i> Auxiliary input/output to the processor (PB6). |
| 18 | SWP DWELL IN | <i>Sweep Dwell Input:</i> Permits a TTL low-level signal to stop the sweep in both analog- and step-sweep modes. The sweep resumes when the signal is removed. |
| 19 | AUX 2 | <i>Aux 2:</i> Auxiliary input/output to the processor (PC3). |
| 20 | BANDSWITCH BLANK | <i>Bandswitch Blanking Output:</i> Provides a +5V or –5V signal coincident with bandswitching points. Signal polarity is selected from a front panel menu. |
| 21 | SPARE | |
| 22 | HORIZ IN | <i>Horizontal Sweep Input:</i> Accepts a 0V to 10V external sweep ramp from a Master sweep generator. This input is automatically selected when the sweep generator is in the Slave Mode. |
| 23 | Return | Horizontal Sweep Input return. |
| 24 | TXb | <i>TXb:</i> Serial Data Output from the processor. |
| 25 | MEMORY SEQ | <i>Memory Sequencing Input:</i> Accepts a TTL low-level signal to sequence through nine stored, front panel setups. |

Figure A-2. Pinout Diagram, AUX I/O Connector (2 of 2)

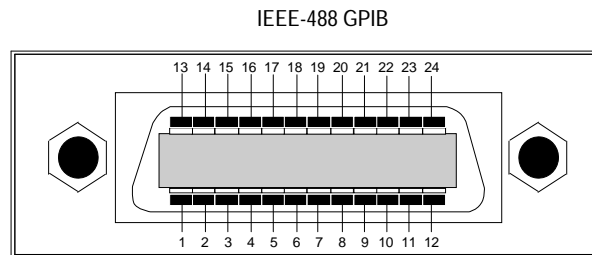

| PIN | SIGNAL NAME | SIGNAL DESCRIPTION |
|-------|------------------|---|
| 1-4 | DIO 1 thru DIO 4 | <i>Data Input/Output:</i> Bits are HIGH when the data is logical 0 and LOW when the data is logical 1. |
| 5 | EOI | <i>End or Identify:</i> A low-true state indicates that the last byte of a multibyte message has been placed on the line. |
| 6 | DAV | <i>Data Valid:</i> A low-true state indicates that the active talker has (1) sensed that NRFD is high-false and NDAC is low-true, (2) placed the data byte on the bus, and (3) waited an appropriate length of time for the data to settle. |
| 7 | NRFD | <i>Not Ready For Data:</i> A high-false state indicates that all active listeners are ready to accept new data. |
| 8 | NDAC | <i>Not Data Accepted:</i> A low-true state indicates that all addressed listeners have accepted the current data byte for internal processing. |
| 9 | IFC | <i>Interface Clear:</i> A low-true state places all bus instruments in a known, quiescent state—unaddressed to talk, unaddressed to listen, and service request idle. |
| 10 | SRQ | <i>Service Request:</i> A low-true state indicates that a bus instrument desires the immediate attention of the controller. |
| 11 | ATN | <i>Attention:</i> A low-true state indicates that the bus is in the command mode (data lines are carrying bus commands). A high-false state indicates that the bus is in the data mode (data lines are carrying device-dependent instructions or data). |
| 12 | Shield | Chassis Ground |
| 13-16 | DIO5 thru DIO6 | <i>Data Input/Output:</i> Bits are HIGH when the data is logical 0 and LOW when the data is logical 1. |
| 17 | REN | <i>Remote Enable:</i> A low-true state enables bus instruments to be operated remotely, when addressed. |
| 18-24 | GND | Logic Ground |

Figure A-3. Pinout Diagram, IEEE-488 GPIB Connector

Appendix B

Performance Specifications

MODEL SUMMARY

| Model | Frequency Range | Output Power |
|--|---|-------------------------------|
| 68137B | 2.0 to 20.0 GHz | +13 dBm |
| 68147B | 0.01 to 20.0 GHz | +13 dBm |
| 68153B | 2.0 to ≤ 20.0 GHz >20.0 to ≤ 26.5 GHz | +9 dBm +6 dBm |
| 68159B | 0.01 to <2.0 GHz ≥ 2.0 to ≤ 20 GHz >20.0 to ≤ 26.5 GHz | +13 dBm +9 dBm +6 dBm |
| 68163B | 2.0 to ≤ 20.0 GHz >20.0 to ≤ 40.0 GHz | +9 dBm +6 dBm |
| 68169B | 0.01 to <2.0 GHz ≥ 2.0 to ≤ 20.0 GHz >20.0 to ≤ 40.0 GHz | +13 dBm +9 dBm +6 dBm |
| With Option 15 (High Power) Installed | | |
| 68137B | 2.0 to 20.0 GHz | +17 dBm |
| 68147B | 0.01 to <2.0 GHz ≥ 2.0 to ≤ 20.0 GHz | +13 dBm +17 dBm |
| 68153B | 2.0 to ≤ 20.0 GHz >20.0 to ≤ 26.5 GHz | +13 dBm +10 dBm |
| 68159B | 0.01 to <2.0 GHz ≥ 2.0 to ≤ 20 GHz >20.0 to ≤ 26.5 GHz | +13 dBm +13 dBm +10 dBm |
| 68163B | 2.0 to ≤ 20.0 GHz >20.0 to ≤ 40.0 GHz | +13 dBm +6 dBm |
| 68169B | 0.01 to <2.0 GHz ≥ 2.0 to ≤ 20.0 GHz >20.0 to ≤ 40.0 GHz | +13 dBm +13 dBm +6 dBm |

FREQUENCY

CW MODE

Output: Twenty independent, presettable CW frequencies (F0 – F9 and M0 – M9).

Accuracy: Same as internal or external 10 MHz time base.

Internal Time Base Stability:

With Aging: $< 1 \times 10^{-7}$ /day

($< 5 \times 10^{-10}$ /day with Option 16)

With Temperature: $< 2 \times 10^{-8}$ /°C over 0°C to 55°C

($< 2 \times 10^{-10}$ /°C with Option 16)

Resolution:

1 kHz (0.1 Hz with Option 11)

External 10 MHz Reference Input: Accepts external 10 MHz ± 100 Hz, 0 to +10 dBm time base signal. Automatically disconnects the internal high-stability time-base option, if installed. BNC, rear panel, 50 Ω impedance.

10 MHz Reference Output: 0.5 Vp-p into 50 Ω , AC coupled. Rear panel BNC; 50 Ω impedance.

Switching Time (typical maximum): <25 ms to be within 1 kHz of final frequency.

ANALOG SWEEP MODE

Sweep Width: Independently selected from 1 MHz to full range continuous sweep. For >100 MHz sweep width, the start, stop and bandswitching frequencies are phase-lock-corrected during sweep. For ≤ 100 MHz sweep widths, the center frequency is phase-lock-corrected.

Accuracy: The lesser of:

± 30 MHz or $\pm (2 \text{ MHz} + 0.25\% \text{ of sweep width})$ for sweep speeds of ≤ 50 MHz/ms.

Sweep Time Range: 30 ms to 99 seconds

PHASE-LOCKED STEP SWEEP MODE

Sweep Width: Independently selected, 1 kHz (0.1 Hz with Option 11) to full range. Every frequency step in sweep range is phase-locked.

Accuracy: Same as internal or external 10 MHz time base.

Resolution (Minimum Step Size):

1 kHz (0.1 Hz with Option 11)

Steps: User-selectable number of steps or the step size.

Number of Steps: Variable from 1 to 10,000

Step Size: 1 kHz (0.1 Hz with Option 11) to the full frequency range of the instrument. (If the step size does not divide into the selected frequency range, the last step is truncated.)

PERFORMANCE SPECIFICATIONS

Dwell Time Per Step: Variable from 1 ms to 99 seconds
Switching Time (typical maximum): <7 ms + 1 ms/GHz step size or <25 ms, whichever is less.

ALTERNATE SWEEP MODE

Sweeps alternately in analog or step sweep between any two sweep ranges. Each sweep range may be associated with a power level.

MANUAL SWEEP MODE

Provides stepped, phase-locked adjustment of frequency between sweep limits. User-selectable number of steps or step size.

360B VNA SOURCE LOCK MODE

Under control of the WILTRON 360B Vector Network Analyzer, the synthesized sweep generator is phase-locked at a typical <7 ms/step sweep speed. Frequency resolution is limited to 100 kHz.

PROGRAMMABLE FREQUENCY AGILITY

Under GPIB control, up to 1000 non-sequential frequencies can be stored and then addressed as a phase-locked step sweep. Data stored in volatile memory.

MARKERS

Up to 20 independent, settable markers (F0 – F9 and M0 – M9).

Video Markers: +5V or –5V marker output, selectable from system menus. BNC and AUX I/O connectors, rear panel.

Intensity Markers (Available in Analog Sweeps of <1 Second Sweep Time): Produces an intensified dot on trace, obtained by momentary dwell in RF sweep.

Marker Accuracy: Same as sweep frequency accuracy.

Marker Resolution (Analog Sweep):

1 MHz or Sweep Width/4096, whichever is greater.

Marker Resolution (Step Sweep):

1 kHz (0.1 Hz with Option 11)

SWEEP TRIGGERING

Sweep triggering is provided for Analog Frequency Sweep, Step Frequency Sweep, and CW Power Sweep.

Auto: Triggers sweep automatically.

External: Accepts a TTL low-level signal of 1 μ s width to trigger a sweep. AUX I/O connector, rear panel.

Single: Triggers, aborts, and resets a single sweep. Reset sweep may be selected to be at the top or bottom of the sweep. The pen lift will activate at sweep speeds ≥ 1 second.

SPECTRAL PURITY

All specifications apply to the phase-locked CW and Step Sweep modes at the lesser of +10 dBm output or maximum specified leveled output power, unless otherwise noted.

SPURIOUS SIGNALS

Harmonic and Harmonic Related:

10 MHz to ≤ 50 MHz: <–30 dBc

>50 MHz to ≤ 2 GHz: <–40 dBc

>2 GHz to ≤ 20 GHz: <–60 dBc

>20 GHz to ≤ 40 GHz: <–40 dBc

Nonharmonics:

10 MHz to ≤ 2 GHz: <–40 dBc

>2 GHz to ≤ 40 GHz: <–60 dBc

SINGLE-SIDEBAND PHASE NOISE

(dBc/Hz)

| Frequency Range (GHz) | Offset From Carrier | | | |
|-----------------------|---------------------|-------|--------|---------|
| | 100 Hz | 1 kHz | 10 kHz | 100 kHz |
| 0.01 to ≤ 8.4 | <–70 | <–78 | <–86 | <–90 |
| >8.4 to ≤ 20 | <–61 | <–74 | <–76 | <–85 |
| >20 to ≤ 40 | <–55 | <–68 | <–70 | <–79 |

POWER LINE and FAN ROTATION SPURIOUS EMISSIONS (dBc)

| Frequency Range (GHz) | Offset From Carrier | | |
|-----------------------|---------------------|----------------|--------|
| | <300 Hz | 300Hz to 1 kHz | >1 kHz |
| 0.01 to ≤ 8.4 | <–50 | <–60 | <–60 |
| >8.4 to ≤ 20 | <–46 | <–56 | <–60 |
| >20 to ≤ 40 | <–40 | <–50 | <–54 |

PERFORMANCE SPECIFICATIONS

RESIDUAL FM (50 Hz - 15 kHz BW)

| Frequency Range (GHz) | Residual FM (Hz RMS) |
|-----------------------|----------------------|
| 0.01 to ≤8.4 | <120 |
| >8.4 to ≤20 | <220 |
| >20 to ≤40 | <440 |

RESIDUAL FM (Analog Sweep and FM modes, 50 Hz - 15 kHz BW)

| Frequency Range (GHz) | Residual FM (kHz RMS) |
|-----------------------|-----------------------|
| 0.01 to ≤8.4 | <10 |
| >8.4 to ≤20 | <20 |
| >20 to ≤40 | <40 |

AM Noise Floor:

Typically <-145 dBm/Hz at 0 dBm output and offsets >5 MHz from carrier.

RF OUTPUT

Power level specifications apply at 25° ±10°C.

MAXIMUM LEVELED OUTPUT POWER

| Model | Output Power | Output Power with Attenuator Option Installed |
|--------|--|--|
| 68137B | +13 dBm | +11 dBm |
| 68147B | +13 dBm | +11 dBm |
| 68153B | +9 dBm, 2 to ≤20 GHz +6 dBm, >20 to ≤26.5 GHz | +7 dBm, 2 to ≤20 GHz +3.5 dBm, >20 to ≤26.5 GHz |
| 68159B | +13 dBm, <2 GHz +9 dBm, ≥2 to ≤20 GHz +6 dBm, >20 to ≤26.5 GHz | +11 dBm, <2 GHz +7 dBm, ≥2 to ≤20 GHz +3.5 dBm, >20 to ≤26.5 GHz |
| 68163B | +9 dBm, 2 to ≤20 GHz +6 dBm, >20 to ≤40 GHz | +7 dBm, 2 to ≤20 GHz +3 dBm, >20 to ≤40 GHz |
| 68169B | +13 dBm, <2 GHz +9 dBm, ≥2 to ≤20 GHz +6 dBm, >20 to ≤40 GHz | +11 dBm, <2 GHz +7 dBm, ≥2 to ≤20 GHz +3 dBm, >20 to ≤40 GHz |

With Option 15 (High Power) Installed

| | | |
|--------|--|---|
| 68137B | +17 dBm | +15 dBm |
| 68147B | +13 dBm, <2 GHz +17 dBm, ≥2 GHz | +11 dBm, <2 GHz +15 dBm, ≥2 GHz |
| 68153B | +13 dBm, 2 to ≤20 GHz +10 dBm, >20 to ≤26.5 GHz | +11 dBm, 2 to ≤20 GHz +7.5 dBm, >20 to ≤26.5 GHz |
| 68159B | +13 dBm, <2 GHz +13 dBm, ≥2 to ≤20 GHz +10 dBm, >20 to ≤26.5 GHz | +11 dBm, <2 GHz +11 dBm, ≥2 to ≤20 GHz +7.5 dBm, >20 to ≤26.5 GHz |
| 68163B | +13 dBm, 2 to ≤20 GHz +6 dBm, >20 to ≤40 GHz | +11 dBm, 2 to ≤20 GHz +3 dBm, >20 to ≤40 GHz |
| 68169B | +13 dBm, <2 GHz +13 dBm, ≥2 to ≤20 GHz +6 dBm, >20 to ≤40 GHz | +11 dBm, <2 GHz +11 dBm, ≥2 to ≤20 GHz +3 dBm, >20 to ≤40 GHz |

LEVELED OUTPUT POWER RANGE

Without an Attenuator: Maximum leveled power to -15 dBm (-20 dBm typical). For units with Option 15 installed, minimum settable power is -5 dBm (-10 dBm typical).

With an Attenuator: Maximum leveled power to -125 dBm (-130 dBm typical). For units with Option 15 installed, minimum settable power is -115 dBm (-120 dBm typical).

UNLEVELED OUTPUT POWER RANGE (typical)

Without an Attenuator: 40 dB below max power.

With an Attenuator: 150 dB below max power.

PERFORMANCE SPECIFICATIONS

POWER LEVEL SWITCHING TIME (to within specified accuracy):

Without Change in Step Attenuator: <50 μ s

With Change in Step Attenuator: <20 ms

ACCURACY AND FLATNESS

Step Sweep and CW Modes

Accuracy: ± 1.0 dB^①

Flatness: ± 0.8 dB^①

Analog Sweep Mode (typical)

| Attenuation Below Max Power | Frequency (GHz) | | |
|-----------------------------|-----------------|--------------|--------------|
| | 0.01-0.05 | 0.05-20 | 20-40 |
| Accuracy | | | |
| 0-12 dB | ± 2.0 dB | ± 1.0 dB | ± 2.0 dB |
| 12-30 dB | ± 3.5 dB | ± 3.5 dB | ± 4.6 dB |
| 30-60 dB | ± 4.0 dB | ± 4.0 dB | ± 5.2 dB |
| 60-122 dB | ± 5.0 dB | ± 5.0 dB | ± 6.2 dB |
| Flatness | | | |
| 0-12 dB | ± 2.0 dB | ± 1.0 dB | ± 2.0 dB |
| 12-30 dB | ± 3.0 dB | ± 3.0 dB | ± 4.1 dB |
| 30-60 dB | ± 3.5 dB | ± 3.5 dB | ± 4.6 dB |
| 60-122 dB | ± 4.0 dB | ± 4.0 dB | ± 5.2 dB |

^① ± 2.0 dB, 0.01-0.05 GHz

OTHER OUTPUT POWER SPECIFICATIONS

Output Power Resolution: 0.01 dB

Source Impedance: 50 Ω nominal

Source SWR (Internal Leveling):

Without Attenuator: <1.7 at <2 GHz typical
<1.6 at 2 to 20 GHz typical
<2.0 at >20 GHz typical

With Attenuator: <2.0 typical

Power Level Stability with Temperature:

0.02 dB/ $^{\circ}$ C typical

Level Offset: Offsets the displayed power level to establish a new reference level.

OUTPUT ON/OFF: Toggles the RF output between an Off and On state. During the Off state, the RF oscillator is turned off. The On or Off state is indicated by two LEDs located below the OUTPUT ON/OFF key on the front panel.

RF On/Off Between Frequency Steps: System menu selection of RF On or RF Off during frequency switching in CW or Step Sweep modes.

RF On/Off During Retrace: System menu selection of RF On or RF Off during retrace.

Internal Leveling: Power is leveled at the output connector in all modes.

External Leveling:

External Detector: Levels output power at a remote detector location. Accepts a positive or negative 0.5 mV to 500 mV input signal from the remote detector. EXT ALC GAIN adjusts the input signal range to an optimum value. BNC connector, front and rear panel.

External Power Meter: Levels output power at a remote power meter location. Accepts a ± 1 V full scale input signal from the remote power meter. EXT ALC GAIN adjusts the input signal range to an optimum value. BNC connector, front and rear panel.

External Leveling Bandwidth:

30 kHz typical in Detector mode.

0.7 Hz typical in Power Meter mode.

User Level Flatness Correction:

Number of points: 2 to 801 points per table

Number of tables: 5 available

Entry modes: GPIB power meter or computed data

CW POWER SWEEP

Range: Sweeps between any two power levels at a single CW frequency.

Resolution: 0.01 dB/step

Accuracy: Same as CW power accuracy.

Step Size: User-controlled, 0.01 dB to the full power range of the instrument.

Step Dwell Time: Variable from 1 ms to 99 seconds. If the sweep crosses a step attenuator setting, there will be a sweep dwell of approximately 20 ms to allow setting of the step attenuator.

SWEEP FREQUENCY/STEP POWER

A power level step occurs after each frequency sweep. Power level remains constant for the length of time required to complete each sweep.

PERFORMANCE SPECIFICATIONS

MODULATION

AMPLITUDE MODULATION

External AM Input: Log AM or Linear AM input, front or rear-panel BNC, 50 Ω or 600 Ω input impedance. All options selectable from modulation menu.

AM Sensitivity:

Log AM: 10 dB/volt

Linear AM: 100% per volt

AM Depth (typical with RF level at 6 dB below maximum rated output): 0-90% linear; 20 dB log

AM Bandwidth (3 dB, 50% depth):

DC to 50 kHz minimum

DC to 100 kHz typical

Maximum Input: $\pm 5V$

FREQUENCY MODULATION

External FM Input: Front or rear panel BNC, 50 Ω or 600 Ω input impedance. All options selectable from modulation menu. Carrier frequency is not phase-locked in FM mode to facilitate wideband deviation.

FM Sensitivity: -6 MHz/volt, +10 MHz/volt, or +20 MHz/volt, selectable from modulation menu.

Deviation:

Narrow Mode: 0 to 50 MHz peak minimum, DC to 500 kHz rates.

Wide Mode: 0 to 100 MHz peak minimum, DC to 100 Hz rates.

Distortion at 1 kHz: <10% typical

Maximum Input: $\pm 5V$

SQUARE WAVE MODULATION

The RF output can be pulse modulated via an external modulating signal or an internal square wave generator.

On/Off Ratio: >50 dB

Rise/Fall Time: <1 μs typical

Internal Square Wave Generator: Four square wave signals (400 Hz, 1 kHz, 7.8125 kHz, and 27.8 kHz), selectable from modulation menu.

Accuracy: Same as internal or external 10 MHz time base.

Square Wave Symmetry: 50% $\pm 5\%$ at all power levels

External Input: Front or rear-panel BNC, selectable from modulation menu.

Drive Level: TTL compatible input

Minimum Pulse Width: >5 μs .

Input Logic: Positive-true or negative-true, selectable from modulation menu.

REMOTE OPERATION

All instrument functions, settings, and operating modes (except for power on/standby) are controllable using commands sent from an external computer via the GPIB (IEEE-488 interface bus).

GPIB Address: Selectable from a system menu

IEEE-488 Interface Function Subset:

Source Handshake: SH1

Acceptor Handshake: AH1

Talker: T6

Listener: L4

Service Request: SR1

Remote/Local: RL1

Parallel Poll: PP1

Device Clear: DC1

Device Trigger: DT1

Controller Capability: C0, 1, 2, 3, 28

GPIB Status Annunciators: When the instrument is operating in Remote, the GPIB status annunciators (listed below) will appear in a window on the front panel LCD.

REMOTE: Operating on the GPIB (all instrument front panel keys except for the SYSTEM key and the RETURN TO LOCAL soft-key will be ignored).

LLO (LOCAL LOCKOUT): Disables the RETURN TO LOCAL soft-key. Instrument can be placed in local mode only via GPIB.

Emulations: The instrument responds to the published GPIB commands and responses of the WILTRON Models 6600 and 6700 signal sources. When emulating another signal source, the instrument will be limited to the capabilities, mnemonics, and parameter resolutions of the emulated instrument.

PERFORMANCE SPECIFICATIONS

GENERAL

Stored Setups: Stores front panel settings and nine additional front-panel setups in a non-volatile RAM. A system menu allows saving and recalling of instrument setups. Whenever the instrument is turned on, control settings come on at the same functions and values existing when the instrument was turned off.

Memory Sequencing Input: Accepts a TTL low-level signal to sequence through nine stored setups. AUX I/O connector, rear panel.

Self-Test: Instrument self-test is performed when Selftest soft-key is selected. If an error is detected, an error message is displayed in a window on the LCD identifying the probable cause and remedy.

Secure Mode: Disables all frequency, power level, and modulation state displays. Stored setups saved in secure mode remain secured when recalled. Mode selectable from a system menu.

Parameter Entry: Instrument-controlled parameters can be entered in three ways—keypad, rotary data knob, or the \wedge and \vee touch pads of the cursor-control key.

The keypad is used to enter new parameter values; the rotary data knob and the cursor-control key are used to edit existing parameter values. The < and > touch pads of the cursor-control key move the cursor left and right one digit under the open parameter. The rotary data knob or the \wedge and \vee touch pads will increment or decrement the digit position over the cursor.

Controlled parameters are frequency, power level, sweep time, dwell time, and number of steps.

Keypad entries are terminated by pressing the appropriate unit key (GHz/Sec/dBm, MHz/ms/dB, kHz/ μ s/STEPS, or Hz/ns/ADRS). Edits are terminated by exiting the edit menu.

Reset: Returns all instrument parameters to predefined default states or values. Any pending GPIB I/O is aborted. Selectable from the system menu.

Master/Slave Operation: Allows two 681XXB output signals to be swept with a user-selected frequency offset. One 681XXB unit controls the other via AUX I/O and SERIAL I/O connections. Requires a Master/Slave Interface Cable Set (Part No. ND36329).

User Level Flatness Correction: Allows user to calibrate out path loss due to external switching and cables via entered power table from a GPIB power meter or calculated data. When user level correction is activated, entered power levels are delivered at the point where calibration was performed. Supported power meters are Anritsu ML4803A and HP 437B, 438A, and 70100A. Five user tables are available with up to 801 points/table.

Warm Up Time (Standard Time Base):

From Standby: 30 minutes.

From Cold Start (0°C): 120 hours to achieve $<1 \times 10^{-7}$ per day frequency stability.

Warm Up Time (Option 16 Time Base):

From Standby: 30 minutes

From Cold Start (0°C): 72 hours to achieve $<5 \times 10^{-10}$ per day frequency stability.

Power:

90-132 Vac or 180-264 Vac, 48-440 Hz, 400 VA maximum

Standby: With ac line power connected, unit is placed in standby when front panel power switch is released from the OPERATE position.

Weight: 23 kg (50 lb) maximum

Dimensions:

133 H x 429 W x 597 D mm

(5.25 H x 16.875 W x 23.5 D in)

RF Output Connector:

Type K female.

ENVIRONMENTAL

Storage Temperature Range: -40°C to $+75^{\circ}\text{C}$.

Operating Temperature Range: 0°C to $+50^{\circ}\text{C}$.

Relative Humidity: 5% to 95% at 40°C .

Altitude: 4,600 meters (15,000 ft) 17.3" Hg.

EMI: Meets the conducted and radiated emission requirements of:

EN55011 Class A/CISPR-11 Class A

EN50082-1-1991

IEC 801-2/1991 4 kV CD, 8 kV AD

IEC 801-3/1984 3 V/m (26-500 MHz)

IEC 801-4/1988 500V

PERFORMANCE SPECIFICATIONS

INPUTS and OUTPUTS

| Input/Output Connectors | | |
|--|---------------|--|
| Nomenclature | Type | Location |
| AM IN | BNC | Front & Rear Panel |
| FM IN | BNC | Front & Rear Panel |
|  IN | BNC | Front & Rear Panel |
| EXT ALC IN | BNC | Front & Rear Panel |
| RF OUTPUT | K-Connector | Standard-Front Panel Option 9K-Rear Panel |
| 10 MHz REF IN | BNC | Rear Panel |
| 10 MHz REF OUT | BNC | Rear Panel |
| HORIZ OUT | BNC | Rear Panel |
| MARKER OUT | BNC | Rear Panel |
| PEN LIFT OUT | BNC | Rear Panel |
| RETRACE BLANK OUT | BNC | Rear Panel |
| SEQ SYNC OUT | BNC | Rear Panel |
| DWELL IN | BNC | Rear Panel |
| V/GHz OUT | BNC | Rear Panel |
| AUX I/O | 25-pin D-type | Rear Panel |
| SERIAL I/O | RJ45 | Rear Panel |
| IEEE-488 GPIB | Type 57 | Rear Panel |

AM IN : Accepts an external signal to AM modulate the RF output signal. Front or rear-panel input, 50Ω or 600Ω impedance, both selectable from front-panel modulation menu.

FM IN : Accepts an external signal to FM modulate the RF output signal. Front or rear-panel input, 50Ω or 600Ω impedance, both selectable from front-panel modulation menu.

 IN : Accepts an external TTL compatible signal to pulse modulate the RF output signal. Front or rear-panel input, selectable from front-panel modulation menu.

EXT ALC IN (External ALC Input): Provides for leveling the RF output signal externally with either a detector or power meter. Signal requirements are shown in the RF Output specifications on page B-3.

RF OUTPUT: Provides for RF output from 50Ω source impedance. K Connector, female. Option 9K moves the RF Output connector to the rear panel.

10 MHz REF IN: Accepts an external 10 MHz \pm 100 Hz, 0 to +10 dBm time-base signal. Automatically disconnects the internal high-stability time-base option, if installed. 50Ω impedance.

10 MHz REF OUT: Provides a 0.5 Vp-p, AC coupled, 10 MHz signal derived from the internal frequency standard. 50Ω impedance.

HORIZ OUT (Horizontal Sweep Output): Provides 0V at beginning and +10V at end of sweep for all sweep modes, regardless of sweep width. In CW mode, the voltage is proportional to frequency between 0V at low end and +10V at the high end of range. In CW mode, if CW RAMP is enabled, a repetitive, 0V to +10V ramp is provided.

MARKER OUT: Provides a +5V or -5V signal at each frequency marker in a sweep. Signal polarity selectable from system menu.

PEN LIFT OUT: Provides normally-open or normally-closed relay contacts, selectable from system menu, during band-switch points and retrace.

RETRACE BLANK OUT: Provides a +5V or -5V signal coincident with sweep retrace. Signal polarity selectable from system menu.

SEQ SYNC OUT (Sequential Sync Output): Provides a +5V signal during retrace, at bandswitching points, and during each frequency step in step sweep mode, -5V during markers, and -10V during the selected marker.

DWELL IN: Accepts an external TTL low-level signal to pause the sweep in both analog and step sweep modes. The sweep resumes when the signal is removed.

V/GHz OUT: Provides a reference voltage relative to the RF output frequency (refer to the table below).

| Model Number | V/GHz Output |
|--------------|--------------|
| 68137B | 1.0V/GHz |
| 68147B | 1.0V/GHz |
| 68153B | 0.5V/GHz |
| 68159B | 0.5V/GHz |
| 68163B | 0.5V/GHz |
| 68169B | 0.5V/GHz |

AUX I/O (Auxiliary Input/Output): Provides for most of the front and rear panel BNC connections through a single, 25-pin, D-type connector. Supports master-slave operation with another 681XXB sweep generator and allows for a single-cable interface with the Model 562 Scalar Network Analyzer and other WILTRON instruments. For a pinout diagram and descriptions, see Appendix A, Figure A-2.

SERIAL I/O (Serial Input/Output): Provides access to RS-232 terminal ports to support service and calibration functions and master-slave operations.

IEEE-488 GPIB: Provides input/output connections for the General Purpose Interface Bus (GPIB). For a pinout diagram, see Appendix A, Figure A-3.

PERFORMANCE SPECIFICATIONS

OPTIONS

Option 1, Rack Mounting: Rack mount kit containing a set of track slides (90° tilt capability), mounting ears, and front panel handles to let the instrument be mounted in a standard 19-inch equipment rack.

Option 2A, 110 dB Step Attenuator: Adds a 10 dB/step attenuator with 110 dB range for models having a high-end frequency of ≤ 26.5 GHz. Rated RF output power is reduced.

Option 2B, 110 dB Step Attenuator: Adds a 10 dB/step attenuator with 110 dB range for models having a high-end frequency of ≤ 40 GHz. Rated RF output power is reduced.

Option 9K, Rear Panel RF Output: Adds an RF output connector (K Connector, female) to the rear panel and deletes the RF output connector on the front panel.

Option 11, 0.1 Hz Frequency Resolution: Provides frequency resolution of 0.1 Hz.

Option 14, WILTRON 360B VNA Compatibility: Modifies rack mounting hardware to mate unit in a WILTRON 360B VNA console.

Option 15, High Power Output: Adds high-power RF components to the instrument in the 2-20 GHz frequency range.

Option 16, High-Stability Time Base: Adds an ovenized, 10 MHz crystal oscillator as a high-stability time base.

Option 17, Delete Front Panel: Deletes the front panel for use in remote control applications where a front panel display and keyboard control are not needed.

Option 19, SCPI Programmability: Adds GPIB command mnemonics complying with Standard Commands for Programmable Instruments (SCPI), Version 1993.0 SCPI programming complies with IEEE 488.2-1987.